

# Grandstream Networks, Inc.

---

## GXV3240 IP Multimedia Phone for Android™

### User Guide



## **COPYRIGHT**

©2016 Grandstream Networks, Inc. <http://www.grandstream.com>

All rights reserved. Information in this document is subject to change without notice. Reproduction or transmittal of the entire or any part, in any form or by any means, electronic or print, for any purpose without the express written permission of Grandstream Networks, Inc. is not permitted.

The latest electronic version of this guide is available for download here:

<http://www.grandstream.com/support>

Grandstream is a registered trademark and Grandstream logo is trademark of Grandstream Networks, Inc. in the United States, Europe and other countries.

## **CAUTION**

Changes or modifications to this product not expressly approved by Grandstream, or operation of this product in any way other than as detailed by this guide, could void your manufacturer warranty.

## **WARNING**

Please do not use a different power adaptor with devices as it may cause damage to the products and void the manufacturer warranty.



## FCC Caution

Any Changes or modifications not expressly approved by the party responsible for compliance could void the user's authority to operate the equipment. This device complies with part 15 of the FCC Rules. Operation is subject to the following two conditions: (1) This device may not cause harmful interference, and (2) this device must accept any interference received, including interference that may cause undesired operation.

**Note:** This equipment has been tested and found to comply with the limits for a Class B digital device, pursuant to part 15 of the FCC Rules. These limits are designed to provide reasonable protection against harmful interference in a residential installation. This equipment generates uses and can radiate radio frequency energy and, if not installed and used in accordance with the instructions, may cause harmful interference to radio communications. However, there is no guarantee that interference will not occur in a particular installation. If this equipment does cause harmful interference to radio or television reception, which can be determined by turning the equipment off and on, the user is encouraged to try to correct the interference by one or more of the following measures:

- Reorient or relocate the receiving antenna.
- Increase the separation between the equipment and receiver.
- Connect the equipment into an outlet on a circuit different from that to which the receiver is connected.
- Consult the dealer or an experienced radio/TV technician for help.

## RF Exposure Information (SAR)

This device is designed and manufactured not to be exceeded the emission limits for exposure to radio frequency RF energy set by the Federal Communications Commission of the United States. The exposure standard for wireless devices employing a unit of measurement is known as the Specific Absorption Rate (SAR), and the SAR limit set by FCC is 1.6 W/kg.

This device is complied with SAR for general population/uncontrolled exposure limits in ANSI/IEEE C95.1-1992, and has been tested in accordance with the measurement methods and procedures specified in OET Bulletin 65 Supplement C. This device has been tested, and meets the FCC RF exposure guidelines when tested with the device directly contacted to the body. RF exposure compliance with anybody-worn accessory, which contains metal, was not tested and certified, and use such body-worn accessory should be avoided.

Changes or modifications not expressly approved by the party responsible for compliance could void the user's authority to operate the equipment.

Hereby, Grandstream declares that this device is in compliance with the essential requirements and other relevant provisions of Directive 1999/5/EC.



## GNU GPL INFORMATION

GXV3240 firmware contains third-party software licensed under the GNU General Public License (GPL). Grandstream uses software under the specific terms of the GPL. Please see the GNU General Public License (GPL) for the exact terms and conditions of the license.

Grandstream GNU GPL related source code can be downloaded from Grandstream web site from:

[http://www.grandstream.com/sites/default/files/Resources/gxv32xx\\_gpl.zip](http://www.grandstream.com/sites/default/files/Resources/gxv32xx_gpl.zip)



# Table of Content

<b>DOCUMENT PURPOSE .....</b>	<b>15</b>
<b>CHANGE LOG .....</b>	<b>16</b>
Firmware Version 1.0.3.92 .....	16
Firmware Version 1.0.3.75 .....	16
Firmware Version 1.0.3.62 .....	16
Firmware Version 1.0.3.55 .....	16
Firmware Version 1.0.3.46 .....	16
Firmware Version 1.0.3.37 .....	16
Firmware Version 1.0.3.30 .....	16
Firmware Version 1.0.3.22 .....	16
Firmware Version 1.0.3.6 .....	17
Firmware Version 1.0.1.54 .....	17
Firmware Version 1.0.1.39 .....	17
Firmware Version 1.0.1.29 .....	17
<b>WELCOME .....</b>	<b>18</b>
<b>PRODUCT OVERVIEW .....</b>	<b>19</b>
Feature Highlights .....	19
GXV3240 Technical Specifications .....	20
<b>GETTING STARTED .....</b>	<b>22</b>
Equipment Packaging .....	22
GXV3240 Phone Setup .....	23
<i>Using the phone stand</i> .....	23
<i>Using the slots for wall mounting</i> .....	23
Description of the GXV3240 .....	24
Connecting the GXV3240 .....	25
GXV3240 Extension Module (GXP2200EXT) .....	25
<b>GETTING TO KNOW GXV3240 .....</b>	<b>27</b>
Use The Touchscreen .....	27
Use The Desktop .....	29
<i>Desktop Menu</i> .....	29
<i>Add Application Shortcut to Desktop</i> .....	30
<i>Add Widget to Desktop</i> .....	31
<i>Manage Desktop Items</i> .....	32
<i>Set Wallpapers</i> .....	34
<i>Manage Running Applications</i> .....	35



Idle Screen.....	36
<i>Switch Idle Screens</i> .....	36
<i>Set Up Idle Screen</i> .....	36
Use The Status Bar.....	37
Notifications in Status Bar.....	38
<i>System Settings in Status Bar</i> .....	41
Use The GXV3240 Keypad.....	42
<i>Keypad Shortcut Functions</i> .....	43
Use The Onscreen Keyboard.....	43
Use The Message Waiting Indicator.....	45
<b>MAKE PHONE CALLS.....</b>	<b>46</b>
Register Sip Accounts.....	46
<i>Account Status</i> .....	46
<i>Configure SIP Account</i> .....	46
<i>Set Programmable Keys On Unregistered Account</i> .....	48
Dial A Number Directly.....	49
Redial.....	49
Dial A Number Via Contacts.....	49
Dial A Number Via Call History.....	50
Direct IP Call.....	50
Answer A Call.....	52
<i>Single Incoming Call</i> .....	52
<i>Multiple Calls/Call Waiting</i> .....	55
Call Hold.....	56
Call Recording.....	56
Mute.....	57
Turn On Video During Audio Call.....	57
Switch Audio Channel During Call.....	58
Call Transfer.....	59
<i>Blind Transfer</i> .....	60
<i>Attended Transfer</i> .....	60
6-Way Conference.....	63
<i>Initiate Conference</i> .....	63
<i>Remove Party from Conference</i> .....	65
<i>End Conference</i> .....	65
<i>Hold and Resume Conference</i> .....	65
<i>Auto Conference Mode</i> .....	65
Missed Call.....	66
DND (Do Not Disturb).....	66
Voicemail/Message Waiting Indication.....	67



Call Forward.....	68
Multi-Purpose Keys.....	69
Shared Call Appearance (SCA) .....	71
Call Features.....	73
<b>CONTACTS.....</b>	<b>76</b>
Local Contacts .....	76
Add Single Contacts .....	77
Import/Export Contacts .....	78
Download Contacts.....	80
Search Contacts .....	80
Use Contacts .....	81
<i>Make A Call to Contacts</i> .....	81
<i>Send SMS Message to Contacts</i> .....	81
<i>Select Contacts</i> .....	81
<i>Add Contacts to Favorites</i> .....	81
<i>Edit Contacts</i> .....	82
<i>Send Contacts to Desktop Shortcut</i> .....	83
<i>Share Contacts Via Bluetooth</i> .....	83
<i>Add Contacts to Blacklist</i> .....	83
<i>Add Group</i> .....	83
<i>Contacts Storage Status</i> .....	84
Add Account to Sync Up Contacts.....	84
<b>LDAP PHONEBOOK.....</b>	<b>87</b>
<b>BROADWORKS XSI CONTACTS .....</b>	<b>88</b>
<b>BLACKLIST .....</b>	<b>89</b>
Block History .....	89
<i>Restore Blocked Number</i> .....	89
<i>Delete Block History</i> .....	90
Edit Blacklist.....	90
<i>Add Blacklist</i> .....	90
<i>Edit Blacklist</i> .....	91
<i>Delete Blacklist</i> .....	91
Blacklist Settings.....	92
<b>CALL HISTORY .....</b>	<b>93</b>
Local Call History .....	93
<i>Dial Out from Call History</i> .....	94
<i>Call History Options</i> .....	94
<i>Delete Call History</i> .....	95



<i>Call History Details</i> .....	95
Broadworks XSI Call History .....	96
<b>SMS</b> .....	<b>97</b>
View SMS .....	97
Create New SMS .....	98
Delete SMS .....	98
<b>CALENDAR</b> .....	<b>99</b>
Sign in Calendar .....	99
View Calendar .....	99
Create Event .....	101
Calendar Options .....	101
<b>EMAIL</b> .....	<b>102</b>
Sign in Email .....	102
Email Options .....	105
<i>Send Email</i> .....	105
<i>Search Email</i> .....	105
<i>Email Folders</i> .....	105
<i>Multiple Email Accounts</i> .....	105
<b>GS MARKET</b> .....	<b>107</b>
View APPS .....	107
Search APPS .....	107
Download and Install APPS .....	107
Update APPS .....	108
Uninstall APPS .....	109
<b>TOOLS</b> .....	<b>110</b>
File Manager .....	110
<i>Copy And Paste Files</i> .....	110
<i>Move Files</i> .....	111
<i>Send Files</i> .....	113
<i>Delete Files</i> .....	114
<i>Rename A File</i> .....	114
<b>FTP SERVER</b> .....	<b>116</b>
<b>RECORDER</b> .....	<b>118</b>
Normal Recorder .....	118
Call Recorder .....	119
Downloads .....	120



IP Location .....	120
Diagnosis .....	121
<b>CAMERA .....</b>	<b>123</b>
Take Picture .....	123
Record Video .....	123
Camera Settings .....	124
Angle Adjustment .....	124
<b>MULTIMEDIA .....</b>	<b>125</b>
Gallery .....	125
Music .....	127
<i>Play Music</i> .....	127
<i>Edit Music</i> .....	128
<i>Sort Music</i> .....	129
<i>Search Music</i> .....	129
<i>Create Playlist</i> .....	129
<i>Edit Playlist</i> .....	130
<b>BROWSER .....</b>	<b>131</b>
<b>RSS NEWS .....</b>	<b>133</b>
Add RSS Widget .....	133
Use RSS Widget .....	133
<i>RSS Widget Settings</i> .....	133
Weather .....	134
<i>Add Weather Widget</i> .....	134
<i>Use Weather Widget</i> .....	134
<i>Weather Settings</i> .....	135
<b>BS-IM&amp;P .....</b>	<b>137</b>
<b>ACTIONURL .....</b>	<b>138</b>
<b>PNP .....</b>	<b>139</b>
Set Up PNP Application .....	139
Enable PNP Feature .....	139
<i>Enable from Web Page</i> .....	139
<i>Enable from LCD</i> .....	140
Use PNP Feature .....	140
<b>CONNECT TO NETWORK AND DEVICES .....</b>	<b>141</b>
Ethernet .....	141
Wi-Fi .....	141



<i>Turn On/Off Wi-Fi</i> .....	141
<i>Add Wi-Fi Networks</i> .....	141
Bluetooth.....	143
<i>Turn On/Off Bluetooth</i> .....	143
<i>Change Bluetooth Device Name</i> .....	143
<i>Pair GXV3240 with A Bluetooth Device</i> .....	144
<i>Unpair A Bluetooth Device</i> .....	144
EHS Headset.....	145
USB.....	145
SD Card.....	145
HDMI Device.....	145
<b>EXPERIENCING THE GXV3240 APPLICATION PHONE</b> .....	<b>149</b>

## Table of Tables

Table 1: GXV3240 Features in a Glance .....	19
Table 2: GXV3240 Technical Specifications.....	20
Table 3: Equipment Packaging .....	22
Table 4: GXV3240 Connectors .....	24
Table 5: GXP2200EXT Packaging .....	25
Table 6: GXV3240 Status Bar Notification Icons .....	38
Table 7: GXV3240 Keys .....	42
Table 8: GXV3240 MWI LED Status .....	45
Table 9: GXV3240 Feature Code .....	73

## Table of Figures

Figure 1: GXV3240 Package Content.....	22
Figure 2: Slots for the wall mount and phone stand on the GXV3240.....	23
Figure 3: Tab on the handset cradle. ....	23
Figure 4: GXV3240 Front View .....	24
Figure 5: GXV3240 Back View.....	24
Figure 6: GXV3240 Back View with GXP2200EXT .....	26
Figure 7: GXV3240 Default Home Screen.....	27
Figure 8: GXV3240 Onscreen Menu.....	28
Figure 9: GXV3240 Finger Gestures on the Touch Screen .....	28
Figure 10: GXV3240 Desktop Menu .....	30
Figure 11: Add Application Shortcut to the Desktop.....	31
Figure 12: Add Widget to the Desktop .....	31
Figure 13: Open Clock Widget.....	32
Figure 14: Resize Digital Clock Widget.....	33
Figure 15: Move Clock Widget.....	33
Figure 16: Remove Clock Widget .....	34
Figure 17: GXV3240 Choose Wallpaper.....	35
Figure 18: GXV3240 Recent Applications.....	35
Figure 19: Set up Home Idle Screen.....	36
Figure 20: Delete Idle Screen .....	37
Figure 21: GXV3240 Top Status Bar.....	37
Figure 22: GXV3240 Top Status Bar – Notification.....	38
Figure 23: System Settings in Status Bar .....	41
Figure 24: GXV3240 Keyboard.....	42
Figure 25: GXV3240 Onscreen Keyboard - English Keyboard.....	44
Figure 26: GXV3240 Onscreen Keyboard - Lowercase and Uppercase.....	44
Figure 27: English Keyboard - Number and Symbols.....	44
Figure 28: GXV3240 Account Widget .....	46
Figure 29: GXV3240 Dial Screen.....	47
Figure 30: Disable Video Call Feature on Dial Screen .....	48
Figure 31: GXV3240 Programmable Keys.....	48
Figure 32: GXV3240 View Contacts .....	50
Figure 33: GXV3240 Call History .....	50
Figure 34: Direct IP Call .....	51
Figure 35: Single Incoming Call - Audio.....	52
Figure 36: Single Incoming Call - Video.....	53
Figure 37: Single Incoming Call – Preview-1 .....	53
Figure 38: Single Incoming Call – Preview-2.....	54
Figure 39: Single Incoming Call - Call Forward-1 .....	54



Figure 40: Single Incoming Call - Call Forward-2 .....	55
Figure 41: Call Waiting .....	55
Figure 42: Call On Hold.....	56
Figure 43: GXV3240 Call Recording.....	56
Figure 44: GXV3240 Call Mute .....	57
Figure 45: Turn on Video during Audio Call .....	57
Figure 46: Accept Video during Audio Call.....	58
Figure 47: Switch Audio Channel during Call 1.....	59
Figure 48: Switch Audio Channel during Call 2.....	59
Figure 49: Blind Transfer .....	60
Figure 50: Attended Transfer.....	61
Figure 51: Attended Transfer - Transferring.....	61
Figure 52: Attended Transfer - Split .....	62
Figure 53: Attended Transfer.....	62
Figure 54: GXV3240 Conference Screen .....	63
Figure 55: GXV3240 Conference - Add New Call to the Conference .....	64
Figure 56: GXV3240 Conference - Add Existing Call to Conference .....	64
Figure 57: 4-way Conference Call Established.....	65
Figure 58: Missed Call Screen .....	66
Figure 59: Enable/Disable DND .....	67
Figure 60: Retrieve Voicemail .....	68
Figure 61: Call Forward - Unconditional .....	68
Figure 62: Call Forward - Time Based .....	69
Figure 63: Call Forward - Busy/No Answer.....	69
Figure 64: GXV3240 MPK APP - Add Number .....	70
Figure 65: GXV3240 MPK APP - Add Number from Contacts.....	70
Figure 66: GXV3240 MPK APP - Number List.....	71
Figure 67: GXV3240 SCA Settings on LCD.....	72
Figure 68: GXV3240 SCA Settings on Web UI .....	72
Figure 69: GXV3240 Contacts .....	76
Figure 70: GXV3240 Local Contacts .....	77
Figure 71: GXV3240 Contacts - Add New Contact.....	78
Figure 72: GXV3240 Contacts - Import Contacts .....	79
Figure 73: GXV3240 Contacts - Export Contacts .....	79
Figure 74: GXV3240 Contacts - Download Contacts .....	80
Figure 75: GXV3240 Contacts - Select Contacts.....	81
Figure 76: GXV3240 Contacts - Contacts Options .....	82
Figure 77: Add Contacts to Favorites.....	82
Figure 78: GXV3240 Contacts - Add New Group .....	83
Figure 79: GXV3240 Contacts – Contact Options .....	84
Figure 80: GXV3240 Contacts - Storage Status .....	84



Figure 81: GXV3240 Contacts Options- Account.....	85
Figure 82: Add Account to Sync up in Contacts.....	85
Figure 83: Add Google Account to Sync up in Contacts .....	86
Figure 84: Sign in Google Account .....	86
Figure 85: Restore Blocked Number.....	89
Figure 86: GXV3240 Blacklist - Add Blacklist .....	90
Figure 87: Manually Add Number to Blacklist .....	91
Figure 88: Edit Entry from Blacklist.....	91
Figure 89: Blacklist Settings.....	92
Figure 90: GXV3240 Call History .....	93
Figure 91: GXV3240 Call History .....	94
Figure 92: GXV3240 Call History – Options .....	95
Figure 93: GXV3240 Call History - Details.....	95
Figure 94: GXV3240 SMS Message.....	97
Figure 95: View SMS Dialog .....	97
Figure 96: Create New Message .....	98
Figure 97: Sign In Calendar with Google Account .....	99
Figure 98: View Calendar.....	100
Figure 99: View Calendar by Month.....	100
Figure 100: View Calendar by Day .....	101
Figure 101: Create Event .....	101
Figure 102: Sign in Email .....	102
Figure 103: Select Email Account Type .....	103
Figure 104: Email Account Type - POP3 .....	103
Figure 105: Email Account Type - IMAP .....	104
Figure 106: Email Account Type - EXCHANGE .....	104
Figure 107: Email Account Settings .....	105
Figure 108: Multiple Email Accounts.....	106
Figure 109: GXV3240 GS Market .....	107
Figure 110: GXV3240 GS Market - Downloaded Applications.....	108
Figure 111: GXV3240 GS Market - Installed Applications.....	108
Figure 112: GXV3240 GS Market - Uninstall Applications.....	109
Figure 113: GXV3240 File Manager - Select File .....	110
Figure 114: File Manager Root Directory .....	111
Figure 115: Paste File .....	111
Figure 116: GXV3240 File Manager - Select File .....	112
Figure 117: File Manager Root Directory .....	112
Figure 118: Paste File .....	113
Figure 119: GXV3240 File Manager - Options.....	113
Figure 120: Delete File(s) via File Manager.....	114
Figure 121: Rename File.....	115



Figure 122: FTP Server - Start.....	116
Figure 123: FTP Server - Stop.....	116
Figure 124: FTP Server – Settings.....	117
Figure 125: Normal Recorder.....	118
Figure 126: Normal Recorder - Start Recording.....	119
Figure 127: Normal Recorder - End Recording.....	119
Figure 128: Call Recorder.....	120
Figure 129: Downloads.....	120
Figure 130: GXV3240 Location.....	121
Figure 131: GXV3240 Diagnosis.....	122
Figure 132: GXV3240 Camera.....	123
Figure 133: GXV3240 Camera Settings.....	124
Figure 134: GXV3240 Gallery.....	125
Figure 135: GXV3240 Gallery - Edit Picture.....	126
Figure 136: GXV3240 Gallery - Picture Options.....	126
Figure 137: GXV3240 Music - Refresh Music List.....	127
Figure 138: GXV3240 Music - Play a Song.....	128
Figure 139: GXV3240 Music - Options.....	128
Figure 140: GXV3240 Music - Sort Songs.....	129
Figure 141: GXV3240 Music - Create Playlist.....	130
Figure 142: GXV3240 Web Browser.....	131
Figure 143: GXV3240 Browser Menu Options.....	131
Figure 144: Open New Window in Browser.....	132
Figure 145: GXV3240 Web Browser-Bookmarks.....	132
Figure 146: GXV3240 RSS News.....	133
Figure 147: GXV3240 RSS News Settings.....	134
Figure 148: GXV3240 Weather.....	135
Figure 149: GXV3240 Weather Settings.....	135
Figure 150: GXV3240 Weather Update Settings.....	136
Figure 151: GXV3240 PNP Settings.....	140
Figure 152: GXV3240 Connect to Wi-Fi.....	142
Figure 153: GXV3240 Connect to Wi-Fi-Show Advanced Options.....	142
Figure 154: GXV3240 Bluetooth - Paired Device.....	144
Figure 155: Settings->Display->HDMI.....	146
Figure 156: Settings->Display->HDMI Control.....	146
Figure 157: Settings->Display->HDMI Output Format.....	147
Figure 158: Settings->Display->HDMI Color Mode.....	147
Figure 159: Settings->Display->HDMI Display Settings.....	148
Figure 160: Settings->Display->HDMI Audio Channel Switch.....	148



## DOCUMENT PURPOSE

This document describes how to configure the GXV3240 via phone's LCD menu and web UI menu to fully manipulate phone's features. To learn the advanced functions of GXV3240, please visit <http://www.grandstream.com/support> to download the latest "GXV3240 Administration Guide".

This guide covers following topics:

- [Product Overview](#)
- [Getting started](#)
- [Getting to know GXV3240](#)
- [Make phone calls](#)
- [Contacts](#)
- [Blacklist](#)
- [Call history](#)
- [SMS](#)
- [Calendar](#)
- [Email](#)
- [GS market](#)
- [Tools](#)
- [Recorder](#)
- [Camera](#)
- [Multimedia](#)
- [Browser](#)
- [RSS News](#)
- [BS IM&P](#)
- [Action URL](#)
- [PNP](#)
- [Connect to network and devices](#)
- [Experiencing the GXV3240 applications](#)



## CHANGE LOG

This section documents significant changes from previous versions of user guide for GXV3240. Only major new features or major document updates are listed here. Minor updates for corrections or editing are not documented here.

### **Firmware Version 1.0.3.92**

- Update document layout

### **Firmware Version 1.0.3.75**

- Add Video Display Mode explanations for video answer feature [MAKE PHONE CALLS]
- Add Phonebook Key Function explanations for Phonebook option [CONTACTS]

### **Firmware Version 1.0.3.62**

- Add Disable Video Call Feature option explanations and screenshots for making phone calls [MAKE PHONE CALLS]

### **Firmware Version 1.0.3.55**

- Add Authentication Type for BroadSoft Directories [BROADWORKS XSI CONTACTS]

### **Firmware Version 1.0.3.46**

- Add “End” key to complete attended transfer during attended transferring [ATTENDED TRANSFER]

### **Firmware Version 1.0.3.37**

- Add to consult the third party before attended transferring the call [ATTENDED TRANSFER]

### **Firmware Version 1.0.3.30**

- Add Call Forward option on incoming call page [SINGLE INCOMING CALL]
- Add option to dismiss the prompt missed call log on LCD [MISSED CALL]
- Add option to hide IP address on Account Widget [ACCOUNT STATUS]
- Add Event Notify feature [ACTIONURL]
- Add Mute Key Features While Idle [MUTE]

### **Firmware Version 1.0.3.22**

- Add BS-IM&P [BS-IM&P]



- Add PNP [PNP]
- Update HDMI Device [HDMI DEVICE]

### **Firmware Version 1.0.3.6**

- Add WiFi Static IP and PPPoE Setting [ADD WI-FI NETWORKS]
- Add Set Programmable Keys On Unregistered Account [SET PROGRAMMABLE KEYS ON UNREGISTERED ACCOUNT]

### **Firmware Version 1.0.1.54**

- Add BroadWorks Xsi Contacts [BROADWORKS XSI CONTACTS]
- Add BroadWorks Xsi Call History [BROADWORKS XSI CALL HISTORY]
- Add Preview for video calls Contacts [SINGLE INCOMING CALL]

### **Firmware Version 1.0.1.39**

- Update screenshots

### **Firmware Version 1.0.1.29**

- This is the initial version.



## WELCOME


Thank you for purchasing Grandstream GXV3240 Enterprise Multimedia Phone for Android™. The GXV3240 combines a 6-line IP video phone with the power of a multi-platform video conferencing solution and the convenience of an Android smartphone to offer an all-in-one voice, video, data, and mobility solution. The GXV3240 is a 6-line IP multimedia phone with a 4.3" capacitive touch screen that runs the Android Operating System and therefore offers full access to the hundreds of thousands of Android apps in the Google Play Store - including business productivity apps such as Skype™, Microsoft Lync™, Salesforce1™, and GoToMeeting™. The phone features Gigabit ports, HD audio and HD video, a built-in web browser, integrated Wi-Fi for network flexibility, PoE, and a tiltable CMOS camera. The GXV3240 is compatible with the GXP2200 Extension Module, allowing for quick and easy access to up to 160 contacts at the touch of a finger. The GXV3240's integrated Bluetooth allows users to sync the calendar and contact books on their mobile phones with the GXV3240, to use Bluetooth headsets, and to transfer calls to and from the phone to their mobile phones. By combining a state-of-the-art IP phone, an advanced video conferencing solution, and the Android operating system, businesses throughout the world can now use one IP Phone for all communication and productivity needs.

## PRODUCT OVERVIEW

### Feature Highlights

The following table contains the major features of the GXV3240:

**Table 1: GXV3240 Features in a Glance**

 <p><b>GXV3240</b></p>	<ul style="list-style-type: none"> <li>• 6 lines with up to 6 SIP accounts including FREE IPVideoTalk account with video mail, up to 6-way audio conference and 3-way video conference, phonebook with up to 1000 contacts, call history with up to 1000 records</li> <li>• Dual switched auto-sensing 10/100/1000Mbps network ports, Wi-Fi (802.11b/g/n), PoE+, Bluetooth, USB, SD, HDMI, EHS with Plantronics headsets support</li> <li>• 4.3" (1024x600) capacitive (5 points) touch screen TFT LCD, mega pixel CMOS sensor camera with privacy shutter</li> <li>• HD wideband audio, full-duplex hands-free speakerphone with advanced acoustic echo cancellation</li> <li>• Runs the Android™ Operating System 4.2 and offers full access to the Google Play Store - which includes thousands of business productivity apps such as Skype, Microsoft Lync, SalesForce1, GoToMeeting</li> <li>• Integrate with Grandstream's GXV series of IP video surveillance cameras to view live camera feeds and to receive alerts/alarms from IP cameras installed on the same network</li> <li>• Offers a multi-platform video conferencing solution (Grandstream's Free IPVideoTalk, Skype, Microsoft Lync, and more)</li> <li>• Create Android applications for any business need to run on GXV3240 using Google's API and Grandstream's SDK toolkit</li> </ul>
--	---



## GXV3240 Technical Specifications

The following table resumes all the technical specifications including the protocols / standards supported, voice codecs, telephony features, languages and upgrade/provisioning settings for the GXV3240 phone.

**Table 2: GXV3240 Technical Specifications**

<b>Protocols/Standards</b>	SIP RFC3261, TCP/IP/UDP, RTP/RTCP, HTTP/HTTPS, ARP, ICMP, DNS (A record, SRV, NAPTR), DHCP, PPPoE, SSH, TFTP, NTP, STUN, SIMPLE, LLDP-MED, LDAP, TR-069, 802.1x, TLS, SRTP
<b>Network Interfaces</b>	Dual switched 10/100/1000 Mbps ports with integrated PoE
<b>Graphic Display</b>	4.3"(480*272) capacitive (5 points) touch screen TFT LCD
<b>Camera</b>	Tiltable mega pixel CMOS camera privacy shutter
<b>Bluetooth</b>	Yes, integrated. Bluetooth 4.0 + EDR
<b>Wi-Fi</b>	Yes, integrated. 802.11b/g/n
<b>Auxiliary Ports</b>	RJ9 headset jack (allowing EHS with Plantronics headsets), 3.5mm stereo headset with microphone, dual USB ports, SD, mini HDMI
<b>Feature Keys</b>	11 function keys for PHONEBOOK, BACKSPACE, HEADSET, MUTE, HOLD, MESSAGE, TRANSFER, CONFERENCE, SPEAKERPHONE, SEND/REDIAL, VOLUME. 3 dedicated Android keys for HOME, MENU, and BACK
<b>Voice Codec</b>	Support for G.711 $\mu$ /a, G.722 (wide-band), G.726-32, G.729, iLBC, OPUS, in-band and out-of-band DTMF (In audio, RFC2833, SIP INFO)
<b>Video Codec and Capabilities</b>	H.264 BP/MP/HP, H263, video resolution up to 720p HD, frame rate up to 30 fps, bit rate up to 2Mbps, 3-way video conference, anti-flickering, auto focus and auto exposure, PIP (Picture-in-Picture), on-screen-display, camera block, still picture capture/store, video recording, visual voice message indicator
<b>Telephony Features</b>	Hold, transfer, forward (unconditional/no-answer/busy), call park/pickup, 6-way audio conference, shared-call-appearance (SCA) / bridged-line-appearance (BLA), virtual MPK, downloadable phone book (XML, LDAP), call waiting, call history, boss-secretary virtual button, flexible dial plan, hot desking, personalized music ringtones, server redundancy & fail-over
<b>Sample Applications</b>	Skype, Google Hangouts, Microsoft Lync, Web browser, GoToMeeting, Facebook, Twitter, Youtube, news, weather, stock, Internet Radio, Pandora, Last.fm, Yahoo Flickr, Photo bucket, alarm clock, Google calendar, mobile phone data import/export via Bluetooth, etc. API/SDK available for advanced custom application development
<b>Applications Deployment</b>	Allow various Android operating system 4.2 compliant applications to be developed, downloaded and run in the embedded device with provisioning control
<b>HD Audio</b>	Yes, both handset and speakerphone support HD (wide-band) audio
<b>Base Stand</b>	Yes, integrated stand with multiple adjustable angles. Wall mountable



<b>QoS</b>	Layer 2 QoS (802.1Q, 802.1p) and Layer 3 (ToS, DiffServ, MPLS) QoS
<b>Security</b>	User and administrator level access control, MD5 and MD5-sess based authentication, 256-bit AES encrypted configuration file, TLS, SRTP, HTTPS, 802.1x media access control
<b>Multi-language</b>	English, German, Italian, French, Spanish, Portuguese, Russian, Croatian, Chinese, Korean, Japanese, and more
<b>Upgrade/ Provisioning</b>	Firmware upgrade via TFTP / HTTP / HTTPS or local HTTP upload, mass provisioning using TR-069 or AES encrypted XML configuration file
<b>Power and Green Energy Efficiency</b>	Universal power adapter included: Input: 100-240VAC 50-60Hz; Output: 12VDC, 1.5A (18W); Integrated PoE+ (Power-over-Ethernet) 802.3at, Class 4
<b>Physical</b>	Dimension: 196.5mm (W) x 206.2mm (L) x 85.2mm (H) Unit weight: 0.92kg Package weight: 1.45kg
<b>Temperature and Humidity</b>	Operating: 0°C to 40°C Storage: -10°C to 60°C Humidity: 10% to 90% Non-condensing
<b>Package Content</b>	GXV3240 phone, handset with cord, base stand, universal power supply, network cable, lens cleaning cloth, quick installation guide, brochure, GPL license
<b>Compliance</b>	FCC: Part 15 (CFR47) Class B, Part15C, MPE, UL 60950 (Power Adapter) CE: EN55022 Class B, EN55024 Class B, EN61000-3-2, EN61000-3-3, EN60950-1, EN300-328, EN301-489, EN62311, EN62479, RoHS RCM: AS/ACIF S004, AS/NZS CISPR22/24 Class B, AS/NZS 60950, AS/NZS 4268, AS/NZS 4771



## GETTING STARTED

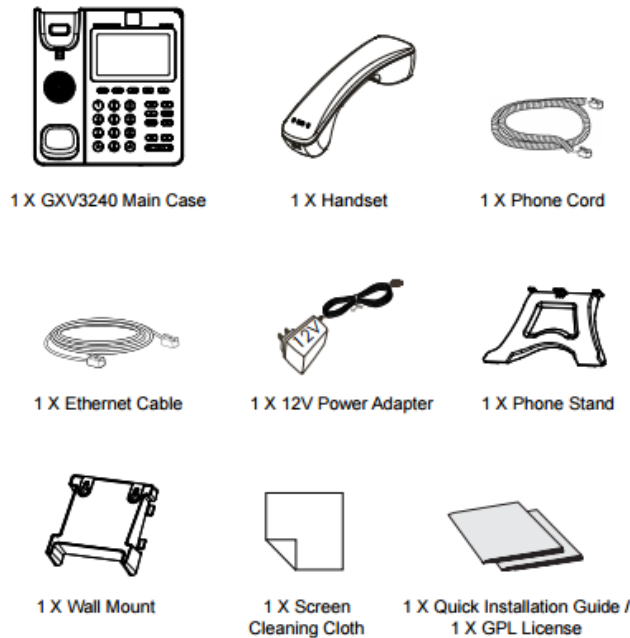
This chapter provides basic installation instructions including the list of the packaging contents and also information for obtaining the best performance with the GXV3240.

### Equipment Packaging

**Table 3: Equipment Packaging**

GXV3240
<ul style="list-style-type: none"> <li>• 1 x GXV3240 Main Case.</li> <li>• 1 x Handset.</li> <li>• 1 x Phone Card.</li> <li>• 1 x Ethernet Cable.</li> <li>• 1 x 12V Power Adapter.</li> <li>• 1 x Wall Mount.</li> <li>• 1 x Phone Stand.</li> <li>• 1 x Screen Cleaning Cloth</li> <li>• 1 x Quick Installation Guide.</li> <li>• 1 x GPL License.</li> </ul>

**Figure 1: GXV3240 Package Content**



**Note:** Check the package before installation. If you find anything missing, contact your system administrator.



## GXV3240 Phone Setup

The GXV3240 can be installed on the desktop using the built-in stand or attached on the wall using the slots for wall mounting.

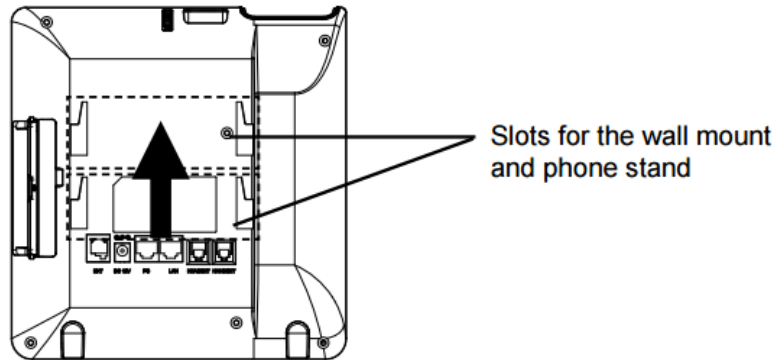


Figure 2: Slots for the wall mount and phone stand on the GXV3240.

### Using the phone stand

The GXV3240 has a built-in phone stand. To set up the GXV3240 as your desk phone, follow the steps below:

1. Attach the phone stand to the back of the phone where there is a slot for the phone stand. Upper part and bottom part are available for two angles;
2. Connect the handset and main phone case with the phone cord;

### Using the slots for wall mounting

1. Attach the wall mount to the slots on the back of the phone;
2. Attach the phone to the wall via the wall mount hole;
3. Pull out the tab from the handset cradle (see figure below);
4. Rotate the tab and plug it back into the slot with the extension up to hold the handset while the phone is mounted on the wall.

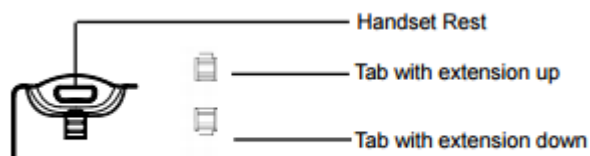


Figure 3: Tab on the handset cradle.

## Description of the GXV3240

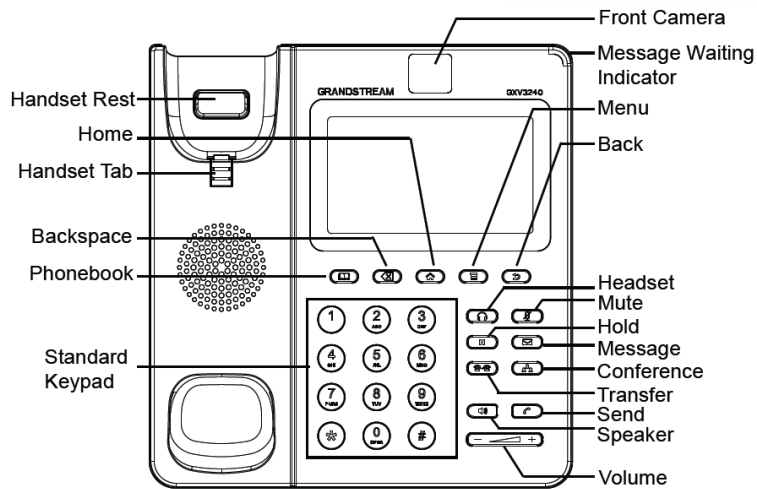


Figure 4: GXV3240 Front View

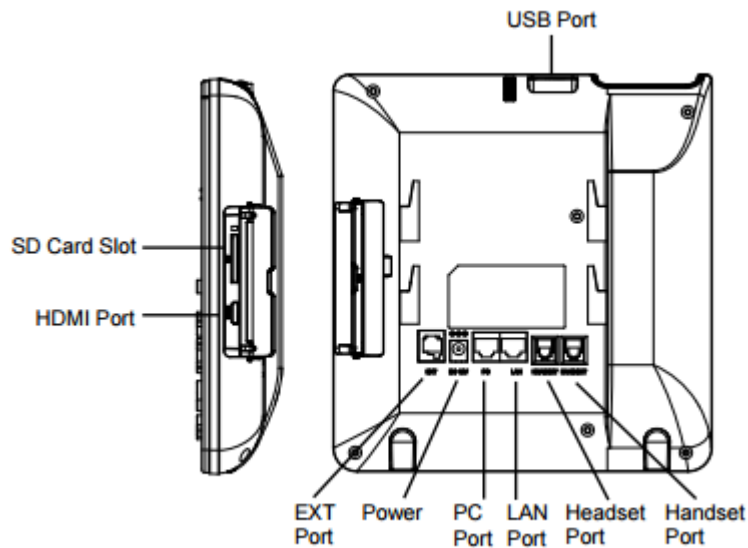


Figure 5: GXV3240 Back View

Table 4: GXV3240 Connectors

<b>USB Port</b>	USB devices can be connected via the USB port. For example, connect a USB flash drive to save captured pictures.
<b>SD Card Slot</b>	Connect SD storage device to the SD Card Slot.
<b>HDMI Port</b>	Connect display device to the HDMI port via HDMI cable.
<b>Headset Port</b>	RJ9 headset connector port.
<b>Handset Port</b>	RJ9 handset connector port.



<b>PC Port</b>	10/100/1000Mbps RJ-45 port connecting to PC.
<b>LAN Port</b>	10/100/1000Mbps RJ-45 port connecting to Ethernet.
<b>Power Jack</b>	12V DC Power connector port.
<b>EXT Port</b>	RJ11 connector port to connect the extension board GXP2200EXT.

## Connecting the GXV3240

To setup your GXV3240, please follow the steps below:

1. Connect the handset and main phone case with the phone cord;
2. Connect the LAN port of the phone to the RJ-45 socket of a hub/switch or a router (LAN side of the router) using the Ethernet cable;
3. Connect the 12V DC output plug to the power jack on the phone; plug the power adapter into an electrical outlet. If PoE switch is used in step 2, this step could be skipped;
4. The LCD will display booting up or firmware upgrading information. Before continuing, please wait for the main screen display to show up;
5. Using the web configuration interface or from the menu of the touch screen, you can further configure network connection using static IP, DHCP and etc.

## GXV3240 Extension Module (GXP2200EXT)

The GXV3240 uses GXP2200EXT as the extension module. The extension module is an ideal solution for the busy enterprise environment looking to add the ability to receive and dispatch calls efficiently. Each GXP2200EXT extension module has 20 programmable buttons, LEFT and RIGHT buttons, supporting 40 Multiple Purpose Keys to be configured. GXV3240 supports up to 4 extension modules, adding 160 fully programmable phone extensions to the phone.

**Table 5: GXP2200EXT Packaging**

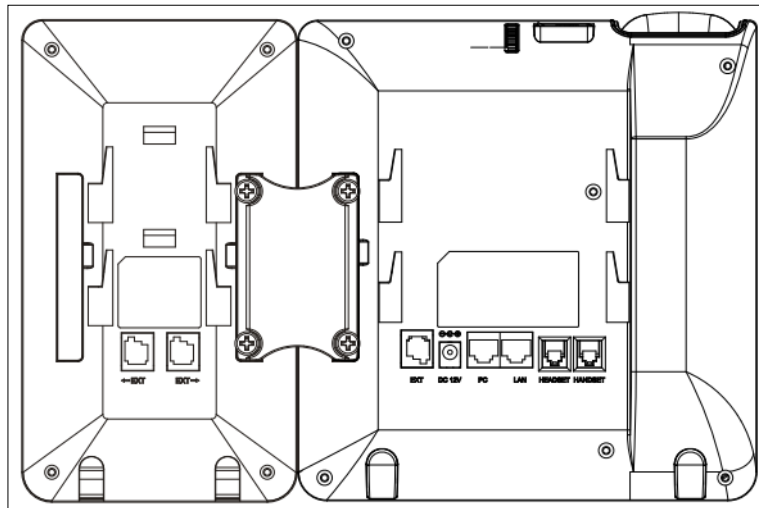
<b>GXP2200EXT Board</b>	1
<b>GXP2200EXT Stand</b>	1
<b>RJ11-RJ11 Cable</b>	1
<b>Connector Plate</b>	1
<b>Screws</b>	4
<b>Quick Installation Guide</b>	1

 **Note:**

The GXP2200EXT is an additional accessory for the GXV3240. Therefore, the GXP2200EXT (including extension module accessories for installation) is not included in the GXV3240 box.

To set up the GXP2200EXT with the GXV3240, please follow the steps below:

1. On the back of the GXV3240 and the GXP2200EXT, there are slots for connector plate. Attach the connector plate between the slots for GXV3240 and the GXP2200EXT;
2. Apply the screws provided and securely tighten them in (See **Figure 6: GXV3240 Back View with GXP2200EXT**);
3. Connect the GXP2200EXT to the GXV3240 via the EXT port using the RJ11-RJ11 cable provided with the GXP2200EXT;
4. Install the phone stand on the GXV3240 and the GXP2200EXT;
5. Power up the GXV3240. The GXP2200EXT will show the booting up screen with version information and connecting status;
6. After successfully booting up, the GXP2200EXT will stay in idle. Press and hold the LEFT button for about 3 seconds to check the version information and status.



**Figure 6: GXV3240 Back View with GXP2200EXT**

The GXP2200EXT can be configured via the web GUI of the GXV3240 connected. After successfully configured, press LEFT or RIGHT button on the GXP2200EXT and users could browse all the MPK's status in different pages.

For more information on installing, connecting and configuring the GXP2200EXT with GXV3240, please refer to the GXP2200EXT user manual in <http://www.grandstream.com/support>.



## GETTING TO KNOW GXV3240

### Use The Touchscreen

When the phone boots up in HOME screen, the LCD will display as below. A registered account is shown in the following figure and users might need register their own account to have the account status displayed.

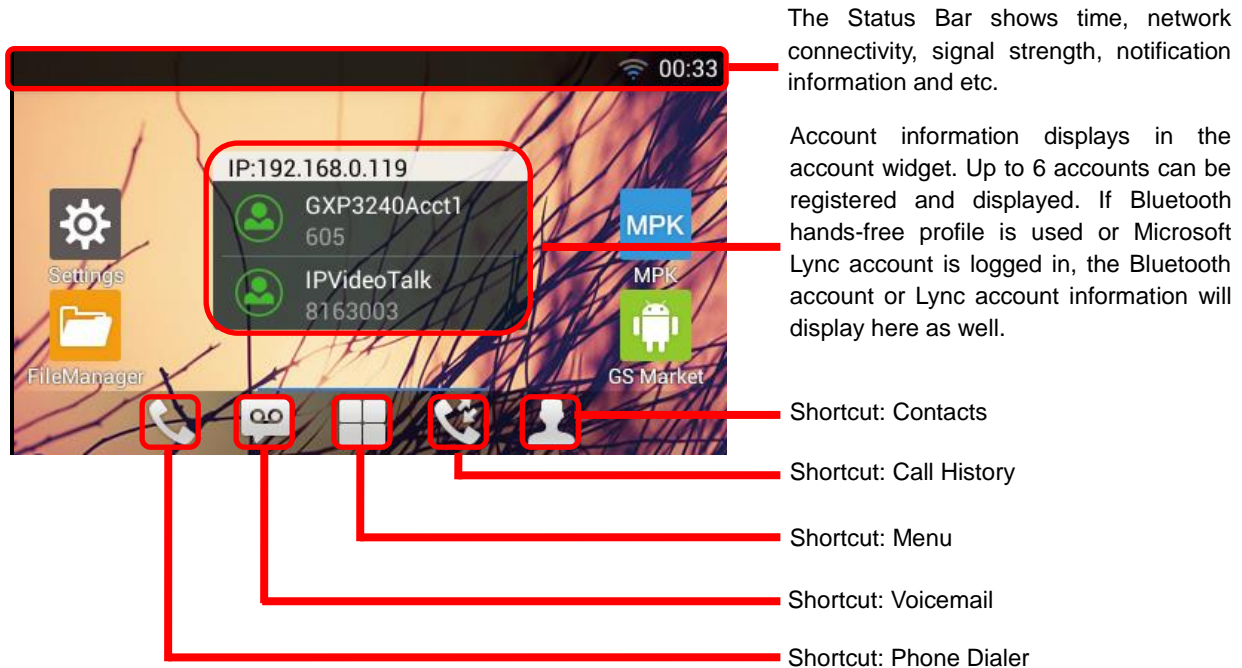


Figure 7: GXV3240 Default Home Screen

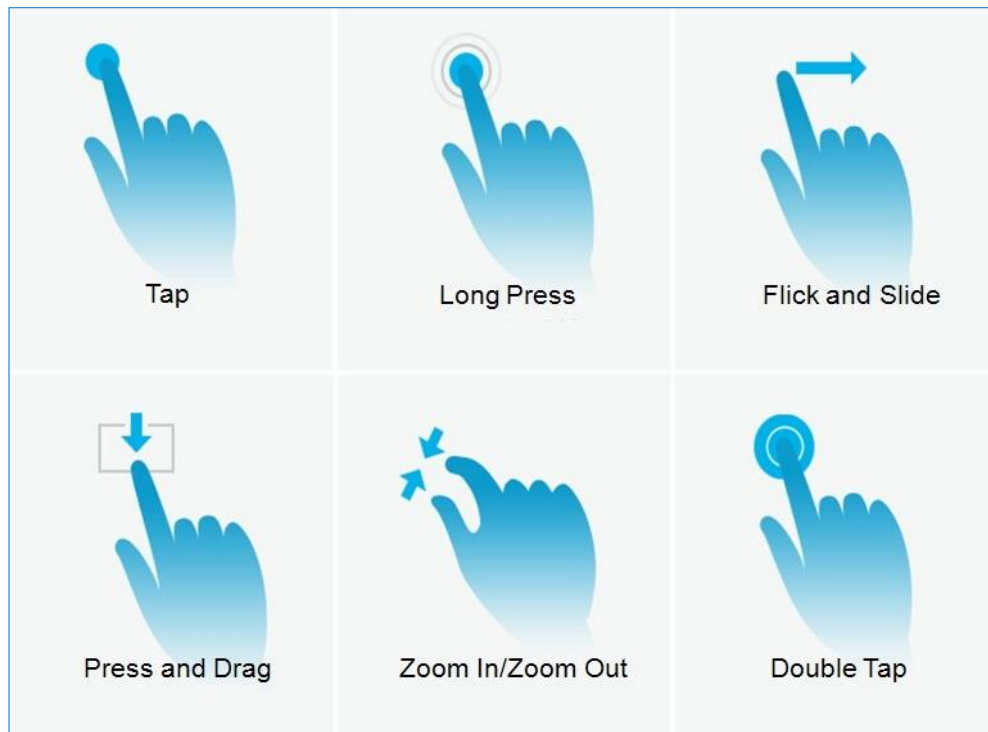
Tap on the onscreen Menu icon , the settings and applications menu will be brought up as shown below.





**Figure 8: GXV3240 Onscreen Menu**

To fully manipulate the GXV3240 capacitive touch screen, use your fingers to operate the following on the GXV3240 icons, buttons, menu items, onscreen keyboard and etc.




**Figure 9: GXV3240 Finger Gestures on the Touch Screen**



- **Tap**  
Slightly touch the screen with fingertip to initiate menu, options or applications. For example, to select items on the screen (e.g., setting options, apps and etc.); to press onscreen buttons (e.g., "End" or "Options" softkey during the call); to type letters and symbols using the onscreen keyboard.
- **Long Press**  
Touch the screen with fingertip and press for about 2 seconds without lifting your finger from the screen till an action occurs. For example, long press on a picture to bring up selection option.
- **Flick and Slide**  
Touch the screen with fingertip and slide over the screen. For example, user could slide up to scroll up the page, slide down to open dropdown menu, slide left or slide right to delete an item from the list. If your finger stays on the screen for too long, the item may be selected and sliding won't occur.
- **Press and Drag**  
Touch and press the item, then move it by dragging it up, down, left or right, without lifting your finger from the screen.
- **Zoom in/Zoom Out**  
Place two fingers on the screen, then pinch them together (zoom out) or spread them apart (zoom in).
- **Double Tap**  
Quickly touch the screen twice with fingertip to switch between default display and zoomed-in display. This is usually used when viewing photos or web pages.

## Use The Desktop

### Desktop Menu

When the GXV3240 is on idle screen, press the MENU key  to bring up phone's menu. Users can access the following in the desktop menu:



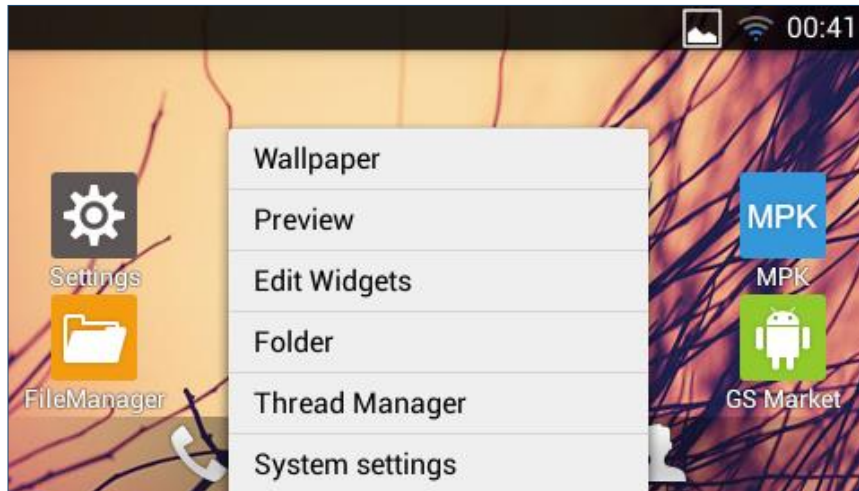


Figure 10: GXV3240 Desktop Menu

- **Wallpaper**  
Select wallpaper from Gallery, Wallpapers or Live Wallpapers.
- **Preview**  
Add, delete or edit desktop.
- **Edit Widget**  
Add widgets to the desktop by dragging the widget from the bottom menu to the desktop.
- **Folder**  
Add folder on the desktop and users can place desktop shortcuts into the folder.
- **Thread Manager**  
Manage running applications on the GXV3240. For more details, please refer to section [\[Manage Running Applications\]](#).
- **System settings**  
Access phone's settings such as "Personalized Account", "Wireless & Network", "Sound", "Display", "Storage", "Application" and etc.

### Add Application Shortcut to Desktop

The shortcut of the applications installed on the GXV3240 can be added to the desktop for users' easy access. To add shortcut:

1. Tap on the on screen Menu icon  to access the applications first.

2. Select and press the application icon for about 2 seconds. The screen will show "Move to Desktop" on the bottom.
3. Drag the icon to the bottom of the screen. Phone's idle screen will immediately show up for you to place the shortcut.

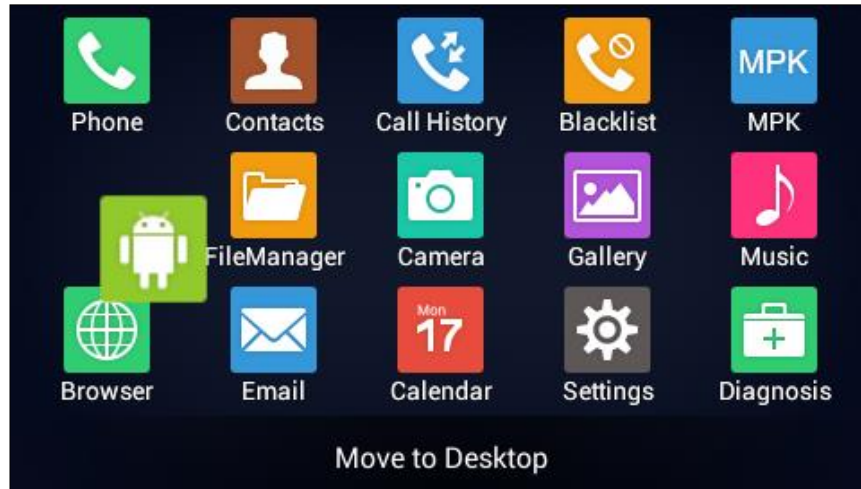


Figure 11: Add Application Shortcut to the Desktop

### Add Widget to Desktop

The GXV3240 provides widgets like account bar (with different number of accounts supported), clock, calendar, contacts, Email, MPK, system setting shortcut, weather and etc. Users could conveniently add those widgets to the desktop as preferred. To add a widget:


1. Press the Menu key  and select "Edit Widgets".
2. Different widgets will be displayed on the bottom of the screen.
3. Select and drag the widget to the desired spot to be placed on the desktop. Please make sure there is enough space on the desktop. Otherwise, the widget won't be added.



Figure 12: Add Widget to the Desktop

## Manage Desktop Items

On the GXV3240 desktop, users could tap on the desktop items to manage shortcuts and widgets. The following operations can be done:

- **Tap on the shortcut icon to open the application.**

For example, tap on "FileManager" icon  to access file manager application.

- **Tap on the widget to open and edit it.**

For example, tap on the digital clock on the desktop. The clock settings will be brought up for users to set up timer, stop watch or alarm.

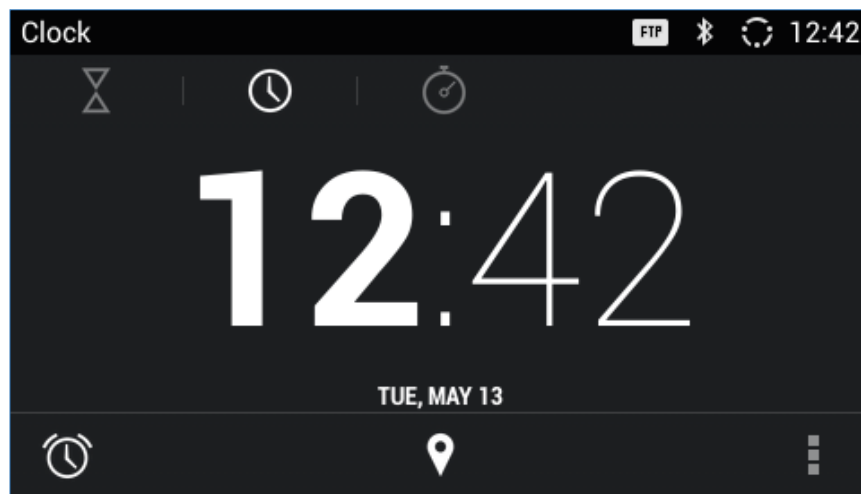


Figure 13: Open Clock Widget

- **Certain widgets such as Calendar, Clock and Bookmark can be resized on the desktop.**

To resize a widget, touch and press the widget for about 2 seconds. Then lift your finger from the screen. This will bring up the blue frame as shown in [Figure 14: Resize Digital Clock Widget]. Touch and drag the border of the frame to adjust the size.



Figure 14: Resize Digital Clock Widget

- **Move the shortcut/widget**

To move a shortcut/widget to a different spot on the desktop or to a different idle screen, touch and press the item for about 2 seconds until a recycle bin icon shows up on the bottom of the screen. Drag the item up/down/left/right to the destination spot on the screen. Lift your finger once done.



Figure 15: Move Clock Widget

- **Remove the shortcut/widget**

To remove an item from the desktop, touch and press the item for about 2 seconds. A recycle bin icon will show up on the bottom of the screen. Drag the item to the recycle bin to remove it.






Figure 16: Remove Clock Widget



**Note:**

Removing operation only removes the shortcut of the application on the screen. The application itself will not be uninstalled.

### Set Wallpapers

On the GXV3240 desktop, touch and press on an empty spot for about 3 seconds to bring up wallpaper settings. Or users could press menu key  and select "Wallpaper" to set up the wallpaper for the desktop. Users could select wallpaper from different categories:

- **Gallery**  
 Open Gallery application and tap on the picture to preview. Touch and drag the blue frame border to select the area of the picture. Then tap on "OK" to set the selected area of the picture as wallpaper.
- **Live Wallpapers**  
 Open a list of sample animated wallpapers built-in with the GXV3240. Select the live wallpaper to preview and then tap on "Set wallpaper".
- **Wallpapers**  
 Open a list of sample wallpapers built-in with the GXV3240. Select the picture to preview and then tap on "Set wallpaper".



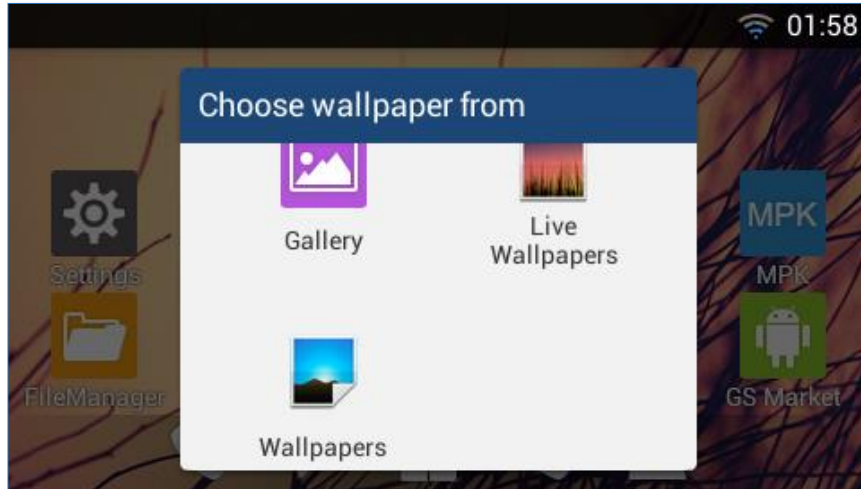


Figure 17: GXV3240 Choose Wallpaper

### Manage Running Applications

On the GXV3240 desktop, press the Home button  for about 2 seconds or select "Thread Manager" after pressing Menu button .

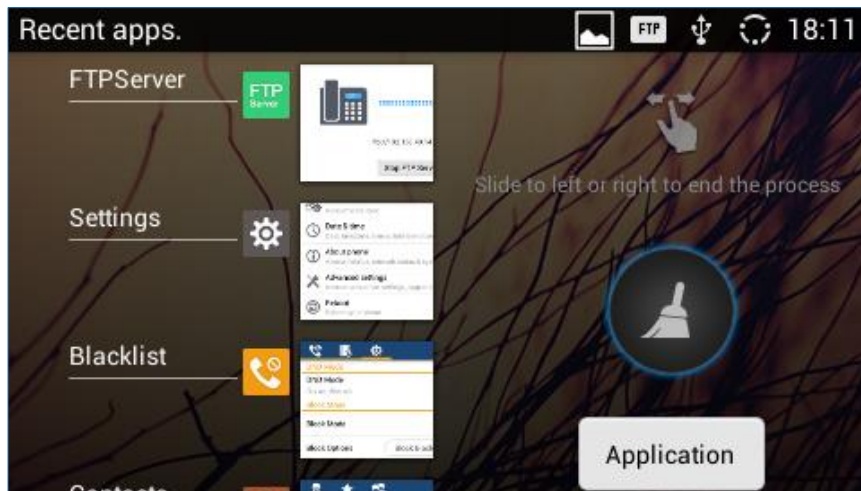



Figure 18: GXV3240 Recent Applications

Users could use the thread manager to do the following:

- Slide the running thread to the left or right to stop the application.
- Tap on icon  to delete all running threads.
- Tap on "Application" softkey to access application menu for advanced management options.



## Idle Screen





### Switch Idle Screens

The GXV3240 supports multiple idle screens by sliding the screen horizontally. On the GXV3240 screen, slightly touch an empty area and slide to the left or right using your finger to switch between different idle screens.

### Set Up Idle Screen

- **Set home screen**

Follow the steps below to set up the HOME screen.

1. GXV3240 is up and running on idle screen.
2. Press the MENU button  and tap on "**Preview**" option. This will zoom out all the screens as shown in **[Figure 19: Set up Home Idle Screen]**.
3. The screen with  displayed is the HOME screen. Others are shown with icon . Tap on the icon  to select the corresponding screen as the new HOME screen.

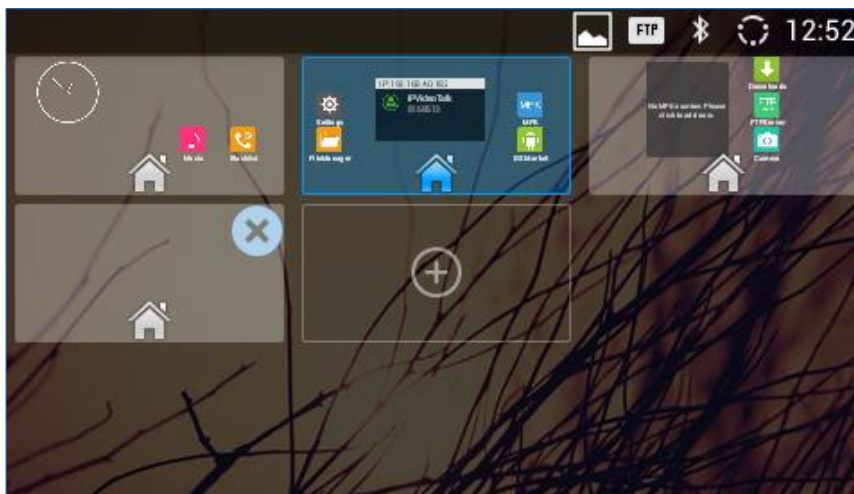



Figure 19: Set up Home Idle Screen

- **Add/Delete idle screen**



As shown in **[Figure 19: Set up Home Idle Screen]**, the screen with the blue frame highlighted is the current idle screen on the LCD. Users could add or delete idle screen.

- Add idle screen.

Tap on  to add a new idle screen. Users could add up to 9 idle screens.



➤ Delete idle screen.

Tap on  on the top right of the idle screen to delete the idle screen. Please make sure the apps, shortcuts or widgets on the idle screen are removed first. Otherwise, the  icon won't show for the idle screen.

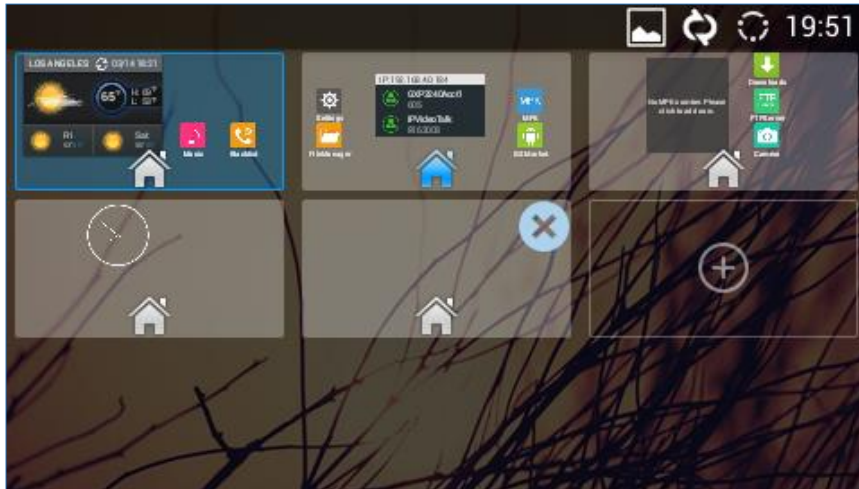


Figure 20: Delete Idle Screen

## Use The Status Bar

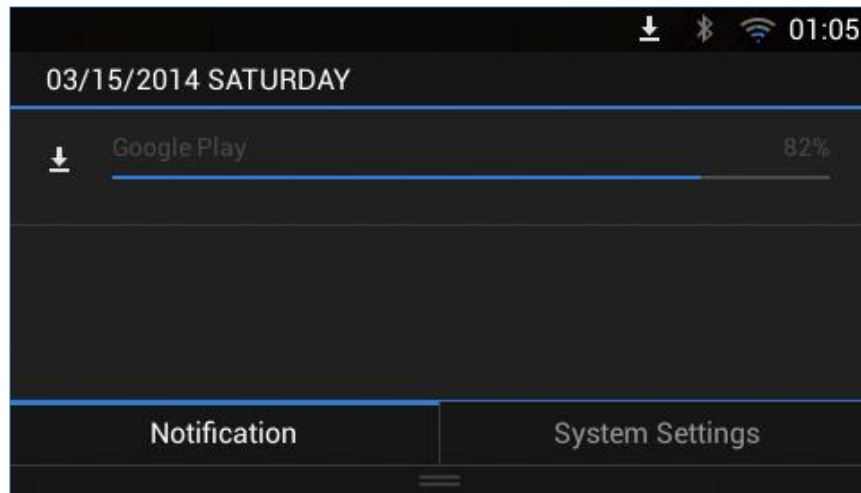
The status bar on the top of the GXV3240 screen provides visual notifications for the system settings and status, as well as quick access for important system settings. To access it, on the GXV3240 idle screen, slowly slide down from the top to the bottom of the screen as the following figure shows.



Figure 21: GXV3240 Top Status Bar

The running process will show up in the list. For example, the following figures indicate the Google Play app is being downloaded at the moment.













**Figure 22: GXV3240 Top Status Bar – Notification**

- Tap on the notification message to view the details.
- Slide the notification message to left side to remove it.















## Notifications in Status Bar

The following table describes the icons used on the status bar for notification purpose.



















**Table 6: GXV3240 Status Bar Notification Icons**

	Network connected via Ethernet cable.
	Trying to connect to the network via Ethernet cable.
	Network disconnected via Ethernet cable.
	Handset is off-hook.
	Missed call.
	One line is active.
	Speaker is being used.
	RJ9 headset is being used.













	RJ9 headset mode is on. All the calls will be using RJ9 headset by default.
	3.5mm earphone is connected.
	3.5mm earphone is being used for calls.
	The system has detected the 3.5mm earphone line order.
	Wi-Fi is enabled and connected. Signal level: 1.
	Wi-Fi is enabled and connected. Signal level: 2.
	Wi-Fi is enabled and connected. Signal level: 3.
	Wi-Fi is enabled and connected. Signal level: 4.
	Onscreen keyboard is activated.
	Bluetooth is enabled and connected.
	Bluetooth is enabled but not connected.
	Bluetooth headset is connected.
	Bluetooth headset is being used for calls.
	Downloading files via Bluetooth.
	Alarm is set up and enabled.
	DND is enabled.
	Mute is enabled.
	Silent mode is enabled. When it's on, the incoming call/message won't produce ring tone/notification tone from phone's speaker.



	SD Card is inserted.
	SD Card space full.
	USB flash drive is inserted.
	Downloading files via Internet connection.
	Updating applications.
	Calendar has event scheduled.
	Unread voicemail to be retrieved.
	Unread Email to be retrieved.
	FTP server is running.
	Incoming call from blacklist contact.
	Camera is disabled.
	Contact storage is full.
	HDMI cable is connected to display device.
	New SMS message to be retrieved.
	SMS Message sent failure.
	The phone is powered up using PoE.
	Call forward is set up for SIP account 1.
	Call forward is set up for SIP account 2.



	Call forward is set up for SIP account 3.
	Call forward is set up for SIP account 4.
	Call forward is set up for SIP account 5.
	Call forward is set up for SIP account 6.
	More notifications on the status bar.
	USB mouse is connected.
	Music is playing using music app.
	PPPoE is connected.
	PPPoE is not connected.
	Warning message.

### System Settings in Status Bar

Slide down the top status bar and select **System Settings**. Users will see the following settings.

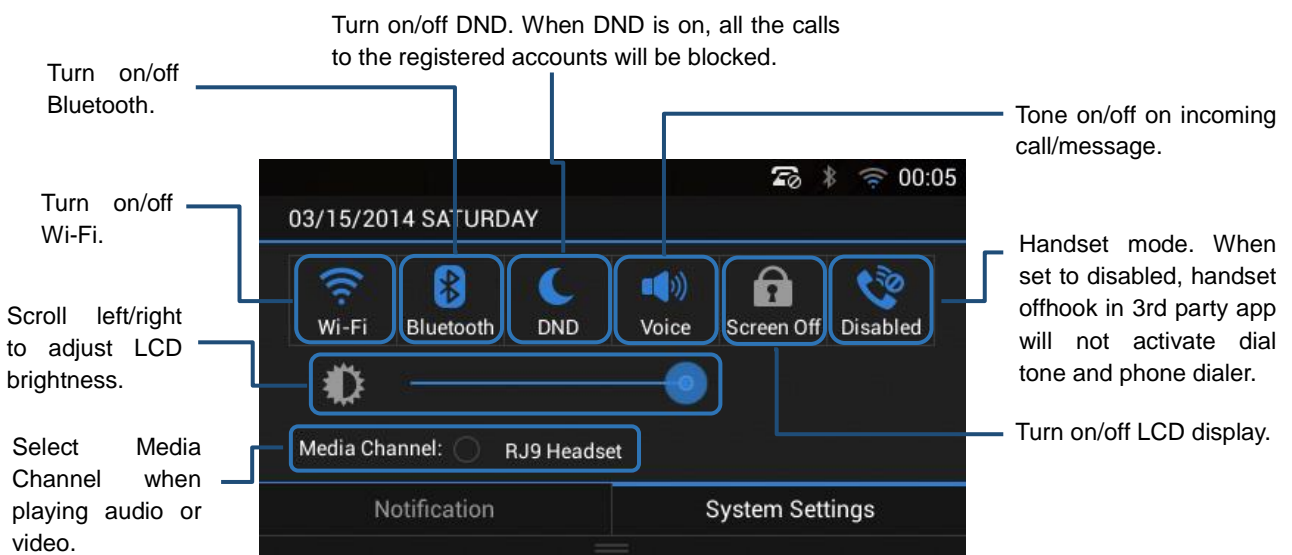


Figure 23: System Settings in Status Bar



**Note:**

**Handset Mode** is for audio path and GXV3240 dialer control when running 3rd party app that uses media path. Currently there are three options supported:

- **Enabled:** Default mode. When handset is lifted, audio will come through handset and the GXV3240 default dial screen will show.
- **Disabled:** In this mode, when running the 3rd party app, if handset is lifted, the audio path will switch to handset but GXV3240 default dial screen won't show (users won't hear dial tone either). Onhook the handset, the audio path will be switched to speaker. Under this mode, even the GXV3240 is not using the 3rd party application, picking up the handset will not activate the GXV3240 dialer. (Users can still use Speaker button to activate GXV3240 dialer under this mode.)
- **Auto:** In this mode, the GXV3240 will automatically detect if the audio path is used by 3rd party app first. If so, it will use the handset mode "Disabled". Otherwise, keep it in "Enabled" mode. Please note that running the 3rd party app doesn't necessarily mean the audio path is used by the 3rd party app. If the audio path is not occupied by the 3rd party app, the GXV3240 will still use the handset mode "Enabled".

## Use The GXV3240 Keypad

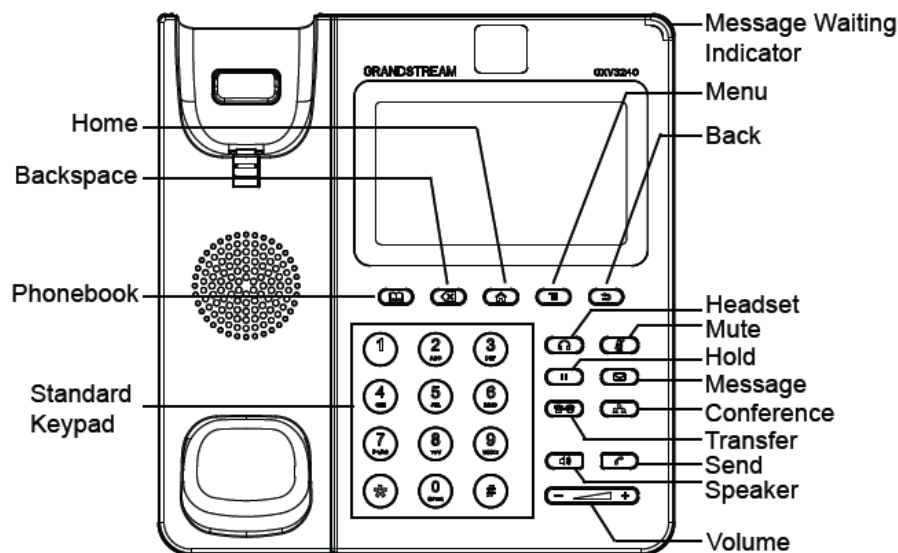
















Figure 24: GXV3240 Keyboard

Table 7: GXV3240 Keys

	<b>Contacts.</b> Press to view and edit contact information.
	<b>Backspace.</b> Press for backspace when entering characters and numbers.




	<b>Home.</b> Press to go back to <b>Home</b> screen; or press and hold it for about 2 seconds, the current running applications and <b>Manage Applications</b> button will show.
	<b>Menu.</b> Press to view options for different screen or applications.
	<b>Back.</b> Press to go back.
	<b>Headset.</b> Press to switch to headset mode.
	<b>Mute.</b> Press to mute or unmute the call.
	<b>Hold.</b> Press to put call on hold or resume the call.
	<b>Message.</b> Press to view voicemail messages.
	<b>Transfer.</b> Press to transfer call.
	<b>Conference.</b> Press to conference call.
	<b>Speaker.</b>
	<b>Send/Redial.</b>
	<b>Volume.</b>

## Keypad Shortcut Functions

The GXV3240 supports keys shortcuts for certain special system functions.

- **Screenshot**

Press and hold the Menu button  for about 3 seconds to capture screenshot. The screenshot can be accessed via **FileManager->Internal Storage->Pictures->Screenshots**. The screenshot picture size is 480x272 pixels.

- **Firmware upgrade via SD card**

Insert the SD card to the GXV3240. The SD card should have the valid firmware bin file in it. Power cycle the phone and the MWI LED will light up. Wait until the MWI LED lights off. Then immediately press both “\*” and “3” keys at the same time for about 8 seconds. Release the keys once the MWI LED lights up again. The phone will start the upgrading process.

## Use The Onscreen Keyboard

The GXV3240 onscreen keyboard can be activated by tapping on an input field.



- **English Keyboard**



This is the default keyboard on GXV3240. Touch and press the  key on the keyboard for about 2 seconds and it will switch to , which can be used to access input options to switch input methods.



Figure 25: GXV3240 Onscreen Keyboard - English Keyboard






To switch input between lowercase and uppercase, tap on  (lowercase) or  (uppercase).



Figure 26: GXV3240 Onscreen Keyboard - Lowercase and Uppercase

- **Number and symbols**

To input number and symbols, tap  on the default keyboard to switch to number/symbols. Tap on  to switch back. Tap on  to access more symbols.

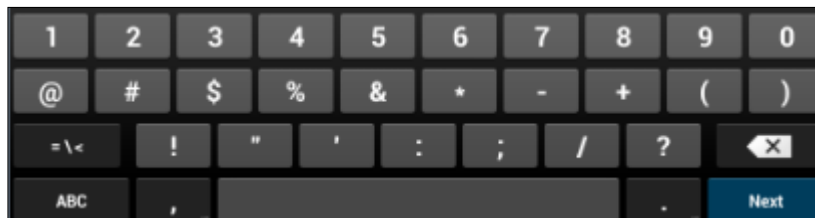



Figure 27: English Keyboard - Number and Symbols

Tap on  to access more symbols.








**Note:**

- To configure keyboard and input options, users could go to **Settings->Language & Keyboard->Keyboard & Input Methods**.
- Users could touch and press the key on the keyboard for about 2 seconds to input the alternative character. For example, touch and press the "+" key for about 2 seconds can get the selection "±".

## Use The Message Waiting Indicator

The GXV3240 message waiting indicator LED is on the upper right corner of the device. It could notify the users with different messages and status of the phone. Please refer to the status description below. **The priority for the LED indicator is from high to low in the following table.**

Table 8: GXV3240 MWI LED Status

Color	LED Status	Description
	Fast Flashing	Incoming call
	Solid	Calling, Talking, Conferencing, Screensaver on when the LCD is off
	Slow Flashing	A call is on hold
	Flashing	Missed call (s), New voicemail (s), New SIP Message (s)
	Solid	High memory usage, Maximum contact storage
	Fast Flashing	Upgrading
OFF	OFF	Normal




## MAKE PHONE CALLS

### Register Sip Accounts

The GXV3240 supports up to 6 independent SIP accounts, including a pre-configured IPVideoTalk account registered on account 6. Users can make video calls and send messages to other IPVideoTalk accounts registered on another GXV32xx/GXV31xx. Each account can have separate SIP servers, usernames and NAT configurations.

#### Account Status

On the idle screen, the account widget shows account name, number and registration status.

- The following figure shows the accounts are successfully registered (account icon is green).
- If the account icon is grey, it's still trying to register or unable to register.
- If the users have enabled Shared Call Appearance on the registered account, the account icon will be blue  .
- Microsoft Lync account and Bluetooth handsfree profile account will be displayed here too (if any).

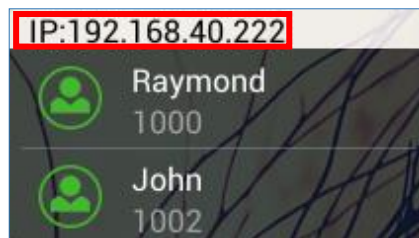


Figure 28: GXV3240 Account Widget

**Note:** Users may go to web UI -> Maintenance -> Network Settings, uncheck “Show IP Address On Account Widget” to hide the IP address of the phone.

#### Configure SIP Account




To register SIP account, users could directly configure from phone's LCD menu->**Settings->Advanced Settings->Account**. Or users could log in the GXV3240 web GUI->**Account** page to fill in the necessary registration information, i.e., Account active, Account name, SIP Server, SIP User ID, SIP Authentication ID, SIP Authentication Password, etc. Once the correct information is entered and saved, the account registration status will show on the main screen.



**Note:**

For web GUI login and configuration information, please refer to GXV3240 Administration Guide.

Once the account is successfully registered, users could use one of the following ways to bring up dial screen to start making calls.

- Take the handset off hook.
- Select an account from the account widget in the idle screen.
- On the bottom of the idle screen, tap on  icon to open dial screen.
- Tap on  to open "Phone" application which will bring up dial screen.
- Press the Speaker button  to bring up dial screen and the audio channel will be speaker.

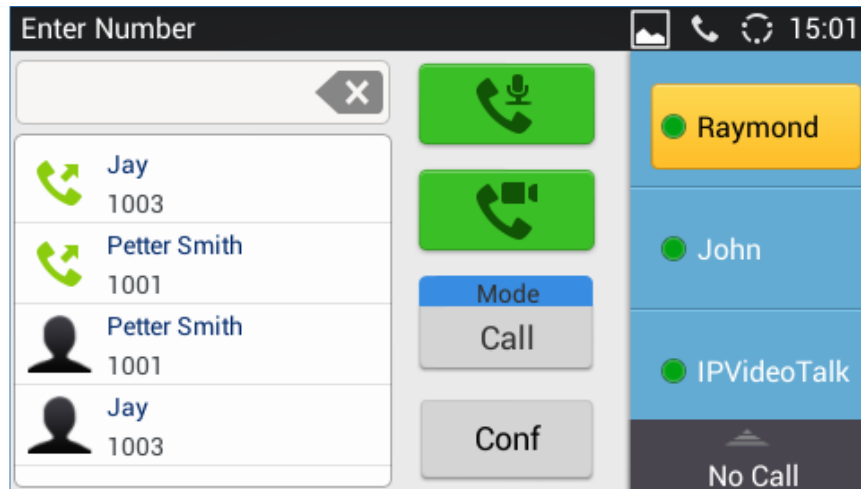


Figure 29: GXV3240 Dial Screen

If **Disable Video Call Feature** option is enabled, the **Video Call** option on GXV3240 dial screen will be hidden.

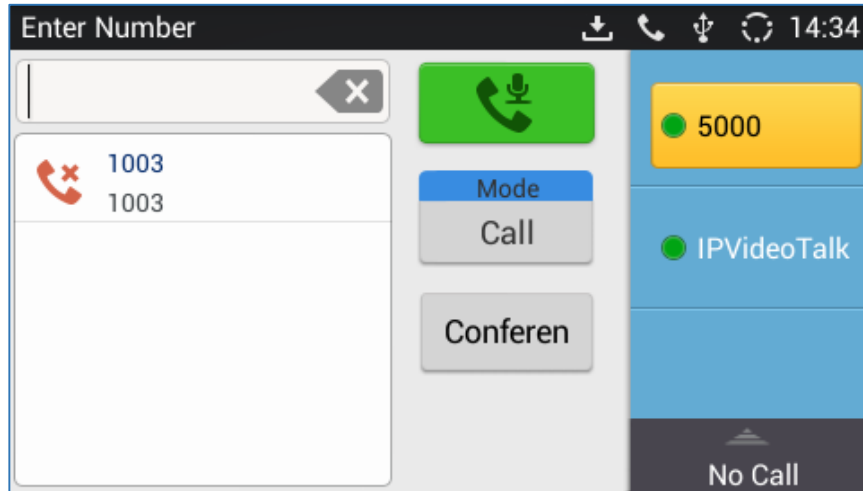


Figure 30: Disable Video Call Feature on Dial Screen

### Set Programmable Keys On Unregistered Account

GXV3240 allows end users to setup shortcut keys on the phone app. The shortcut keys only allow to take place the unregistered accounts. From example, if the phone enables the Account 1 and registers it with a SIP server, end users have to place the shortcut keys on Account 2 to 6.

From Web UI, users can set the shortcut keys under the setting of Account X→Call Settings→Programmable keys. After setting, the programmable keys can be showed on the account bar in the phone app. The following screenshot is a speed dial key which takes place the Account 2 position. End user can tap the key to user Account 1 to dial the number 1001.

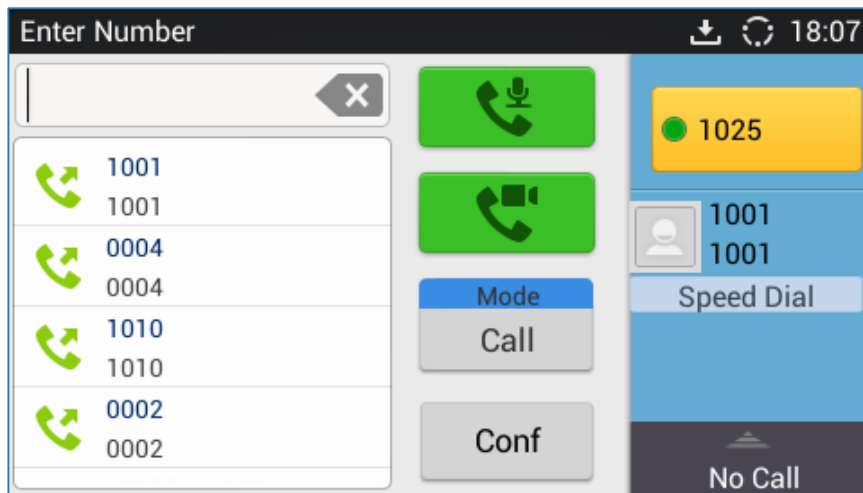





Figure 31: GXV3240 Programmable Keys

## Dial A Number Directly

1. Use the methods mentioned above to open dial screen **[Figure 29: GXV3240 Dial Screen]**.
2. Select the account to dial out on the left panel of the dial screen. The selected account will be highlighted in grey background.
3. Enter the digits to be dialed out using the keypad. If the digit matches call history, a dropdown list of numbers will be displayed for users to select.
4. Tap on  (audio call only) or  (video call), or  (audio call only) to send the number. If no key is pressed, the call will be automatically dialed out after 4 seconds timeout.

---

### **Note:**

- By default, the "No Key Entry Timeout" is 4 seconds, meaning if no key is pressed after starting entering number, the call will be automatically sent out after the timeout. The timeout interval can be configured under web GUI->**Account->Call Settings**.
- GXV3240 allows users to press # key as SEND key. This behavior can be disabled via option "Use # as Dial Key" under web GUI->**Account->Call Settings**.
- When the user enters the digit on the dial screen, if there is digit matching call history, or contacts name/number, the drop-down list will show the numbers. For example, if "John" is saved in the contacts, entering 5 (JKL) 6 (MNO) 4 (GHI) 6 (MNO) will show call log with 5646 as the first four digits, as well as John's number. Users could then directly select one of them from the list, instead of entering all the digits.

---




## Redial

Users can dial out the last dialed number if there is dialed call log, using the same SIP account making the call last time. There are two ways to redial the last dialed number.

- When the phone is idle or off hook, press SEND  button to redial.
- When the phone is on hook, press SEND  button or # button (# key is used as dial key).

## Dial A Number Via Contacts

Follow the steps below to dial a number via Contacts.

1. Access Contacts by tapping on  icon on the bottom of the idle screen, or selecting  from phone's menu.
2. Navigate in the contacts entries by sliding up/down on the screen.
3. Tap on the dial icon for the contact .



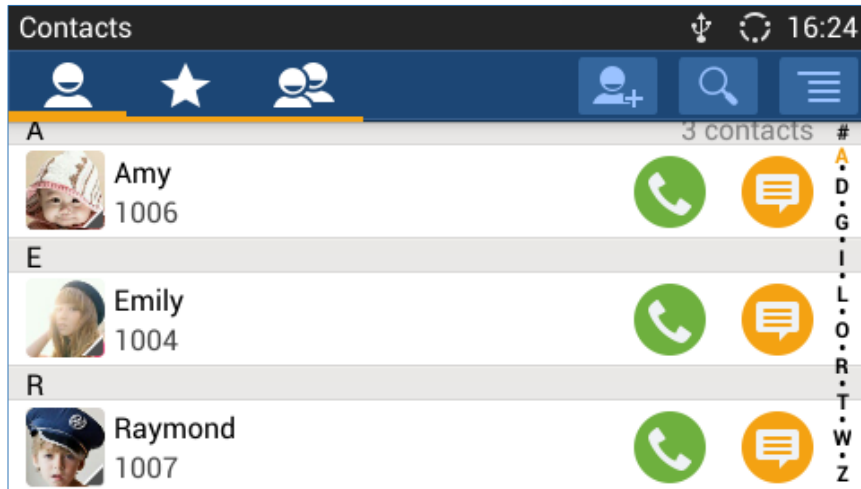




Figure 32: GXV3240 View Contacts

## Dial A Number Via Call History

1. Access Call History by tapping on  icon on the bottom of the idle screen, or selecting  from the phone Menu.
2. The LCD will display all call history types: "All", "Missed", "Outgoing" and "Incoming" calls.
3. Navigate in the call history list by selecting the call history category and sliding up/down on the screen.
4. Tap on the entry to dial out.

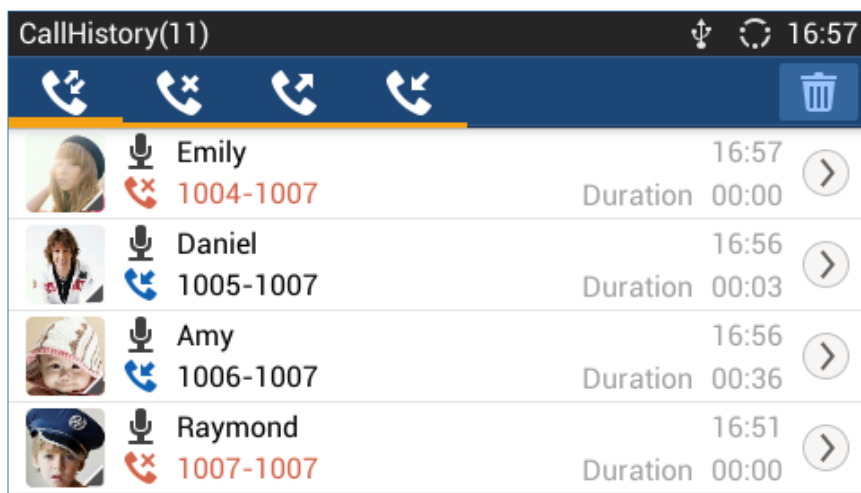


Figure 33: GXV3240 Call History

## Direct IP Call

Direct IP Call allows two phones to talk to each other in an ad-hoc fashion without a SIP proxy. VoIP calls can be made between two phones if:






- Both phones have public IP addresses; Or
- Both phones are on the same LAN/VPN using private or public IP addresses; Or
- Both phones can be connected through a router using public or private IP addresses (with necessary port forwarding or DMZ).

To make a direct IP call, please follow the steps below:

1. Off hook the phone or select account in the idle screen to bring up dial screen on GXV3240;
2. Under "Mode" button in the call screen, tap on it and select the mode as "IP Call";
3. Input the target IP address. For example, if the target IP address is 192.168.0.116 and the port is 5062 (i.e., 192.168.0.116:5062), input the following:

**192\*168\*0\*116#5062**

The \* key represents the dot (.) and the # key represents the colon (:).

4. Press "SEND"  key or tap on  (audio call only) /  (video call) button to dial out.

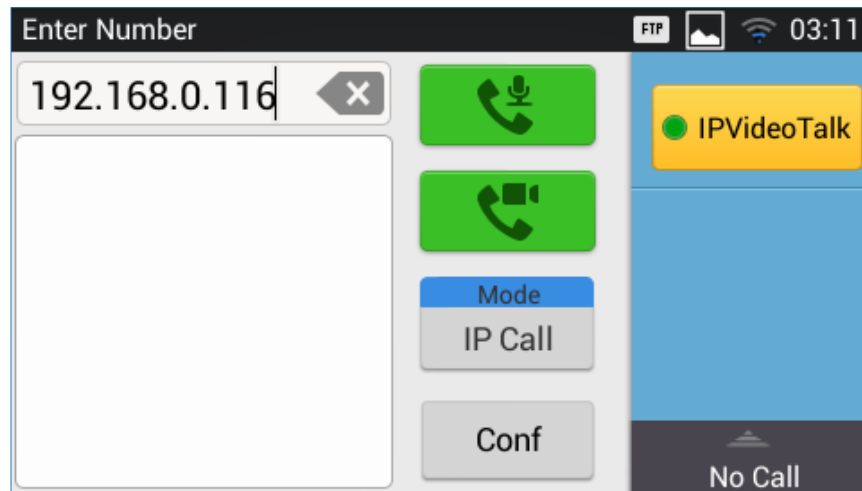


Figure 34: Direct IP Call



**Note:**

- The # will represent colon ":" in direct IP call rather than SEND key as in normal phone call;
- Port number is not mandatory when making direct IP call;
- Users need activate the first account on the GXV3240 to complete direct IP call;
- If you have a SIP server configured, direct IP call still works. If the devices are behind NAT, users might need configure NAT Traversal before using direct IP call. If you are using STUN, direct IP call will also use STUN;
- The phone needs to configure option "Use Random Ports" to "No" to accept direct IP calls;
- In GXV3240 Contacts, if the phone number is IP address, direct IP call can be made by dialing this contact.



## Answer A Call

### Single Incoming Call

- When the phone is in idle and there is an incoming audio call, the phone will show the call screen as below. Tap on "Answer" softkey to answer the call via speaker, or pick up the handset to answer the call.

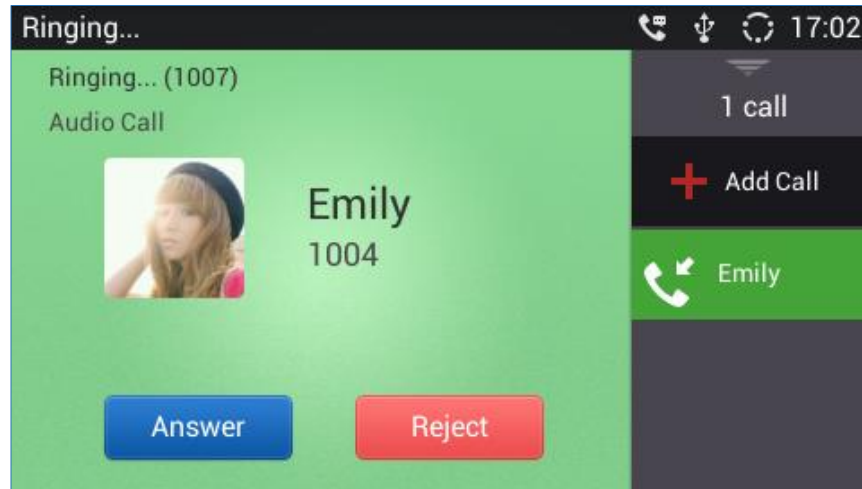


Figure 35: Single Incoming Call - Audio

- When the phone is in idle and there is an incoming video call, the phone will show the call screen as below. To answer the call with audio only, tap on "Audio Answer" to answer the call via speaker, or pick up the handset. To answer the call with both audio and video, tap on "Video Answer". During video call, the audio will switch to handset if picking up the handset.

**Note:** Users could select the **Video Display Mode** on phone's Web UI -> **Advanced Settings** -> **Video Settings**. Set the video display mode to "**Original proportion**", "**Equal proportional cutting**" or "**Proportional add black edge**". If set to "**Original proportion**", the phone displays video in its original proportion. If the video display proportion is different from the one of the phone, the phone will stretch or compress video to display it. If set to "**Equal proportional cutting**", the phone will cut video to meet its own display proportion. If set to "**Proportional add black edge**", the phone will display video in its original proportion, if still exists spare space, the phone will add black edge on it.



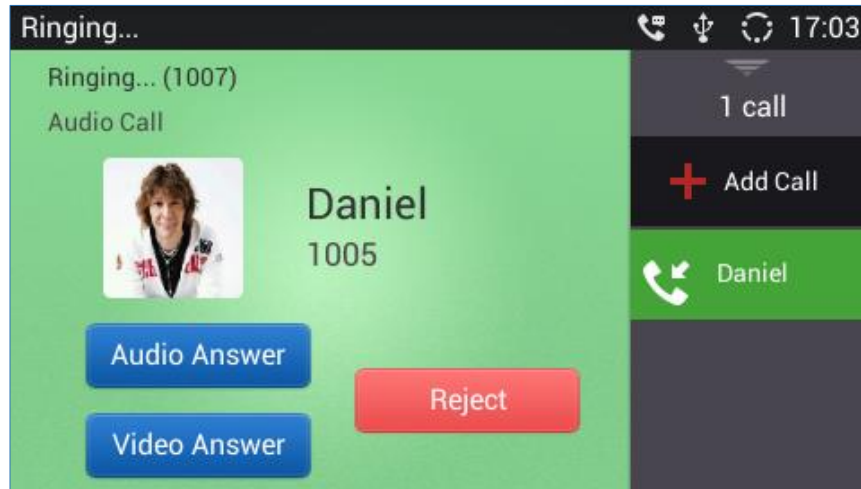


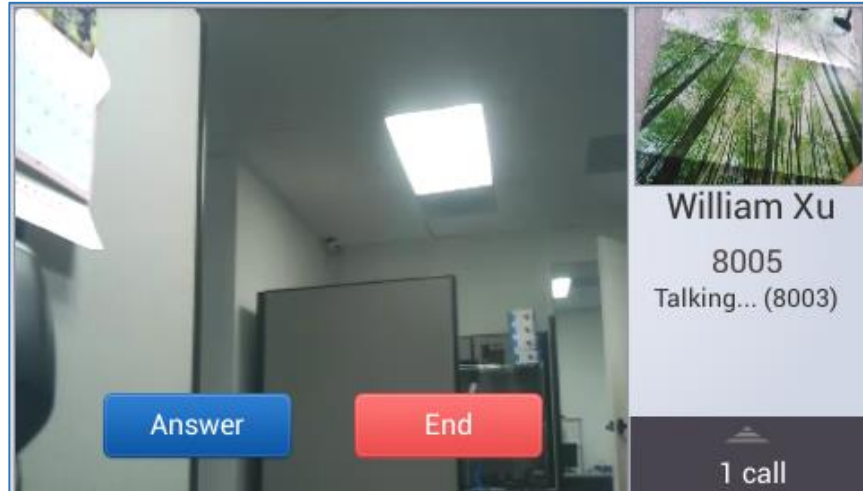
Figure 36: Single Incoming Call - Video

- If the phone set the “Preview” feature for the incoming call from Web UI, the phone will display one more key “Preview” when there is an incoming video call. End users will preview the remote end without answering the video call. After previewing, end user can tap “Answer” key to answer the video call or “Reject” key to reject it. This feature should be supported by the SIP server. Please contact service provider for more information.



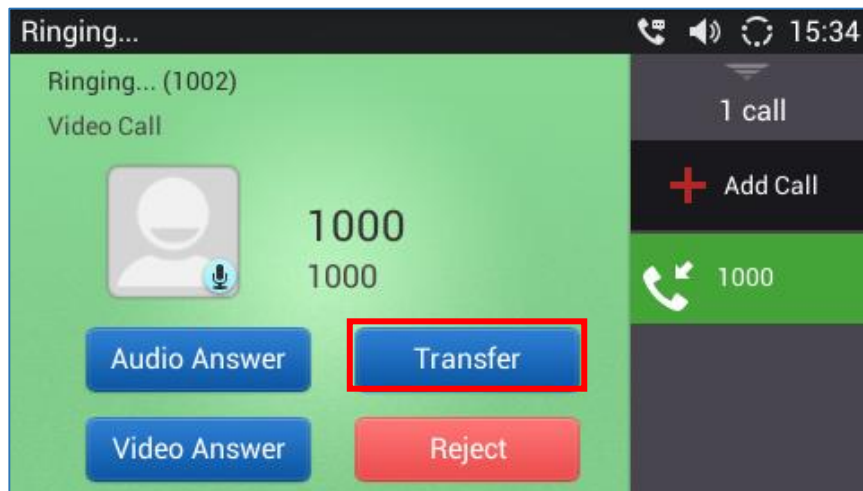
Figure 37: Single Incoming Call – Preview-1





**Figure 38: Single Incoming Call – Preview-2**

- If the phone set to “Call Forward”, the phone system will pop up the “Transfer” key on the LCD screen when there is an incoming call, and users could tap on it to show up the transferring page without answering the incoming call, then, users could transfer this incoming call to others.



**Figure 39: Single Incoming Call - Call Forward-1**



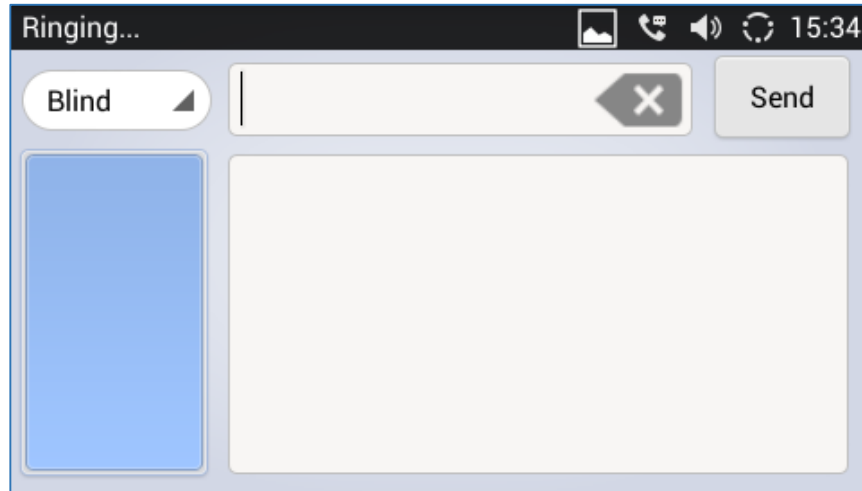


Figure 40: Single Incoming Call - Call Forward-2

### Multiple Calls/Call Waiting

1. When there is another incoming call during active call, users will hear a call waiting tone, with the LCD displaying the caller name and ID for the incoming call. In the right panel, the account bar in green is the ringing line from "Ben"; the account bar in black is the current active call with "John". "3165" is the callee account name.

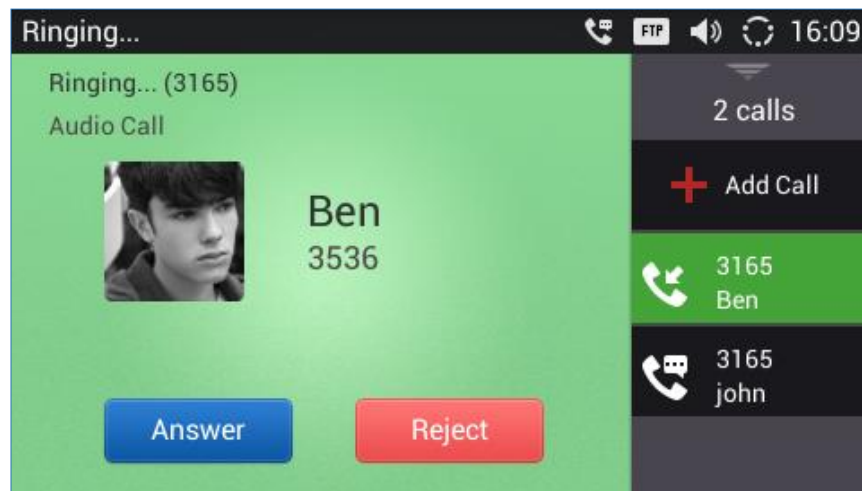



Figure 41: Call Waiting

2. Similar to single incoming call, if the incoming call is video call, users can choose "Audio Answer" or "Video Answer" to answer the call.
3. Once the new call is answered, the current active call will be placed on hold. If the new call is rejected by tapping on "Reject" softkey, the current active call will not be interrupted.



## Call Hold

During the active call, press HOLD button  to put the call on hold. The LCD screen will show as below. To resume the call, press HOLD button again.

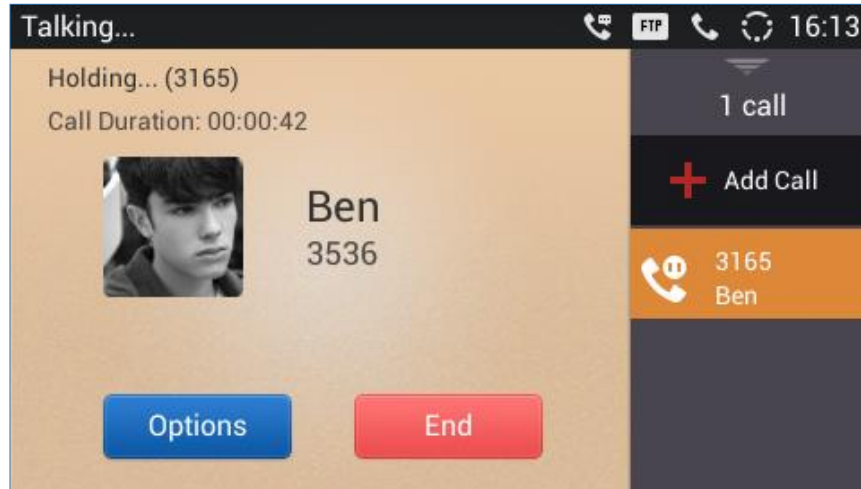


Figure 42: Call On Hold

## Call Recording

1. During the call, users could record the conversation to the phone by tapping on "Options"->"Start Recording" on the call screen.
2. Once done, tap on "Options"->"Stop Recording" or hang up the call.
3. The recording files can be retrieved from the GXV3240 application "Recorder"->"Call" category.

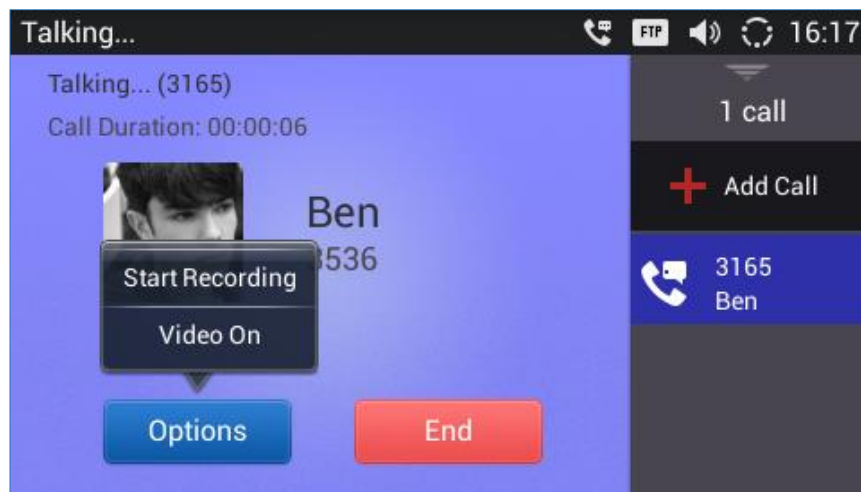





Figure 43: GXV3240 Call Recording

## Mute

During an active call, press the Mute button  to mute the call. The mute icon  will be displayed in the status bar on the top of the screen. Press the Mute button  again to unmute the call.

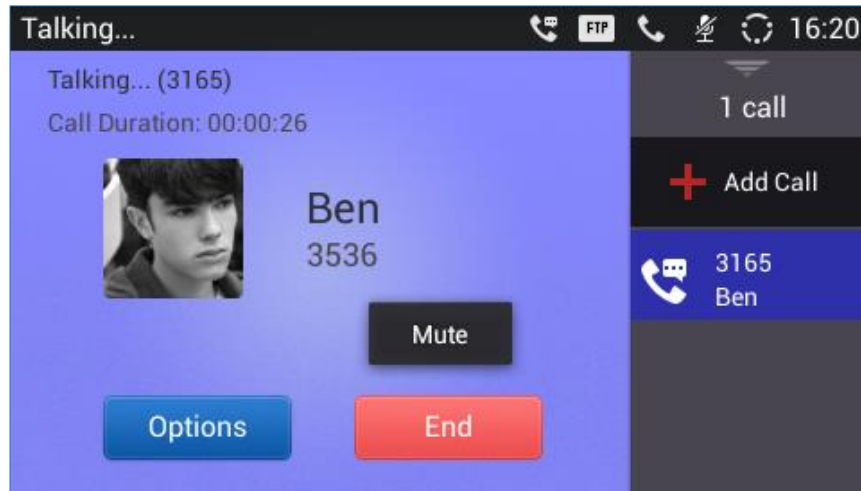


Figure 44: GXV3240 Call Mute

**Note:** Mute key could be set to “DND”, “Idle Mute”, and “Permanent Mute” mode while the phone is at idle state.

## Turn On Video During Audio Call

Users could establish audio call first and then turn on video or accept video request during the call if the other party supports video call as well.

- **Turn on video during audio call**

During an active audio call, on the call screen, tap on "Options" and select "Video On", a video request will be sent to the other party.

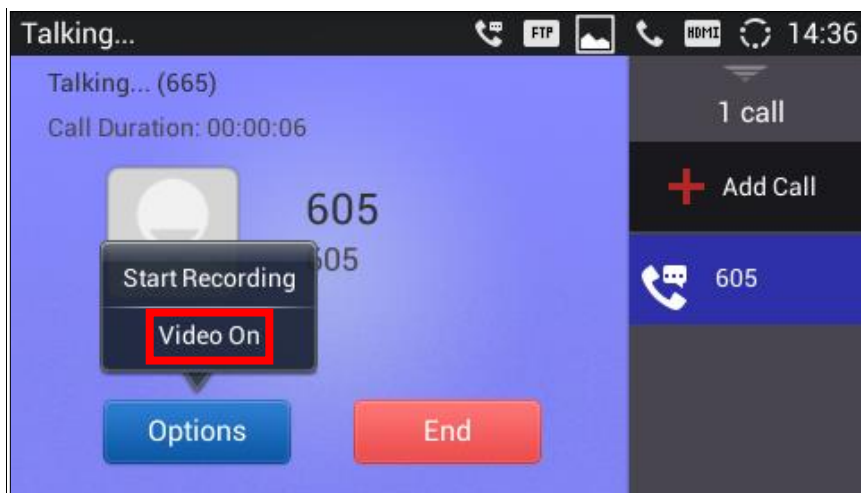


Figure 45: Turn on Video during Audio Call

- **Accept video request**

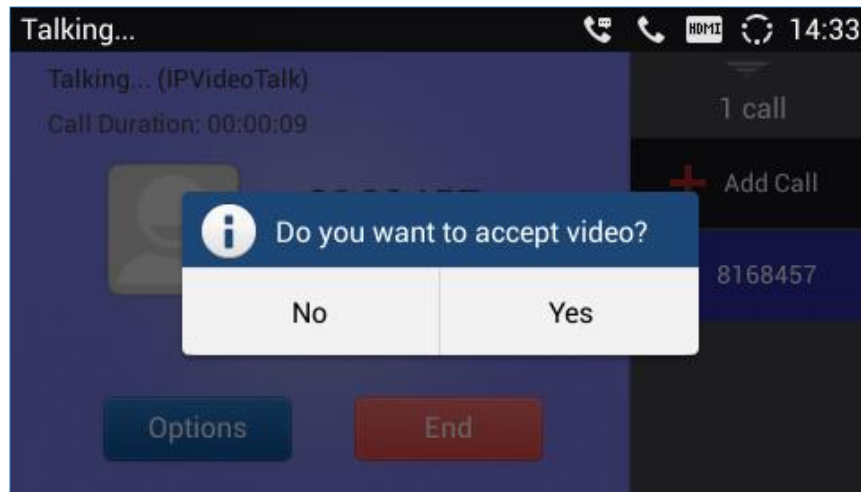





Figure 46: Accept Video during Audio Call

If the GXV3240 receives video request during the audio call, a message "Do you want to accept video?" will be prompted. Select "Yes" to establish video during the call. If the **Disable Video Call Feature** is enabled on GXV3240, the "Video On" option on GXV3240 will be hidden during the audio call. However, if the GXV3240 receives video request during the audio call, users could tap to accept the video request.

## Switch Audio Channel During Call

- The GXV3240 allows users to switch among handset, speaker or headset (RJ9 headset, Plantronics EHS headset and Bluetooth headset) when making calls. Press the Hook Switch to switch to handset; press the Headset button  to switch to headset; press the Speaker button  to switch to speaker; or slide down the "System Settings" menu on talk screen, and press  icon to switch to Bluetooth headset.
- If Bluetooth headset is connected, the audio will be automatically switched to Bluetooth headset once the call is established.
- The status bar on the top or the screen shows the current audio channel being used during the call. If pressing the corresponding key for the currently used audio channel, the call will be hang up.



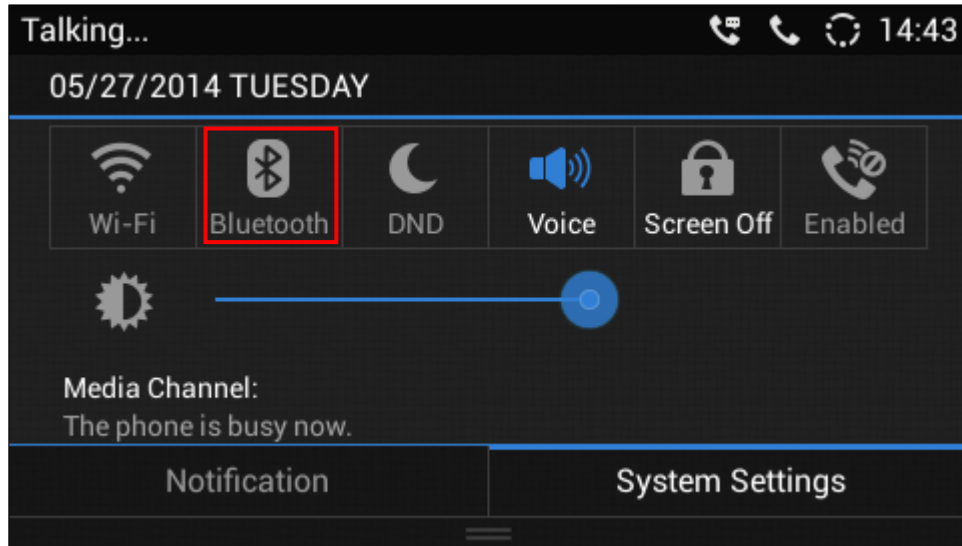


Figure 47: Switch Audio Channel during Call 1

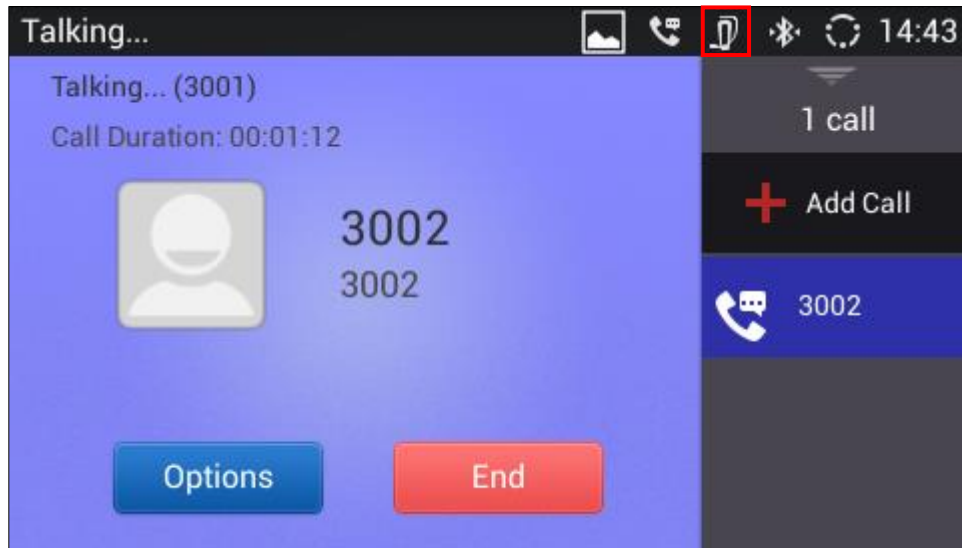



Figure 48: Switch Audio Channel during Call 2

## Call Transfer

A call can be transferred to another party during the call. The GXV3240 supports blind transfer and attended transfer.



## Blind Transfer

1. During the active call, press TRANSFER button  to bring up the transfer screen;
2. Select transfer mode as "Blind" by tapping on the highlight button in the figure below. The default transfer mode is "Blind";
3. Enter the transfer target number and then press the "Send" soft key on the right;
4. The call will be transferred and GXV3240 will hang up the call.

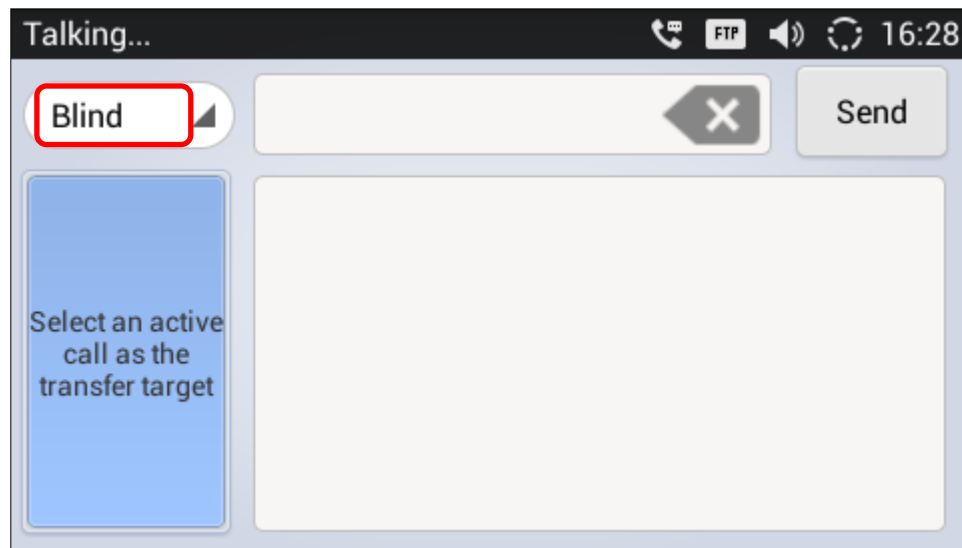




Figure 49: Blind Transfer


---

### Note:

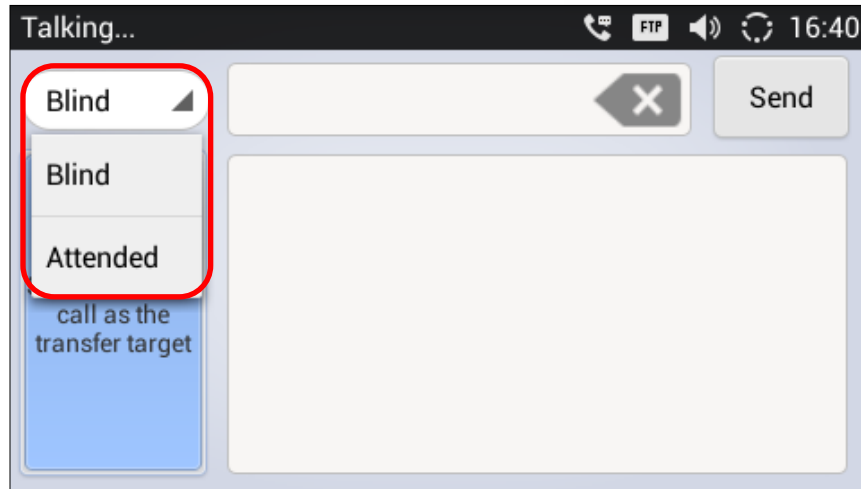
- If wrong digits are entered, tap on  to delete the digit one by one;
  - If users would like to cancel the transfer, press  button to go back to the previous talking screen.
- 

## Attended Transfer

GXV3240 supports attended transfer:

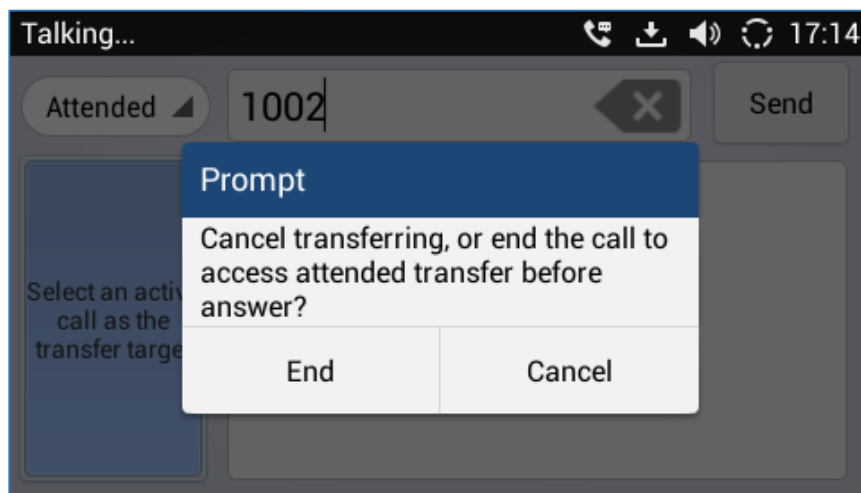
1. During the active call, press TRANSFER button  to bring up the transfer screen;
2. Select transfer mode as "Attended" by tapping on the mode selection bar (see figure below);





**Figure 50: Attended Transfer**

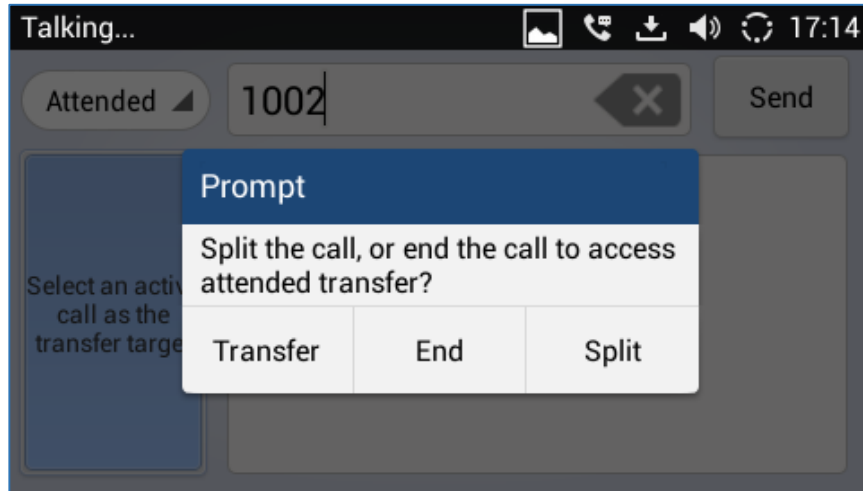
3. Enter the transfer target number, and then press the "Send" soft key on the right.
4. Before transfer target answers the call, GXV3240 hears the ringback tone, and the touch screen prompts shown as below. Users could tap on "Cancel" to cancel the transfer, tap on "End" or simply hang up the call to complete call transfer.



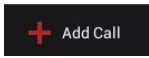

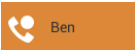

**Figure 51: Attended Transfer - Transferring**

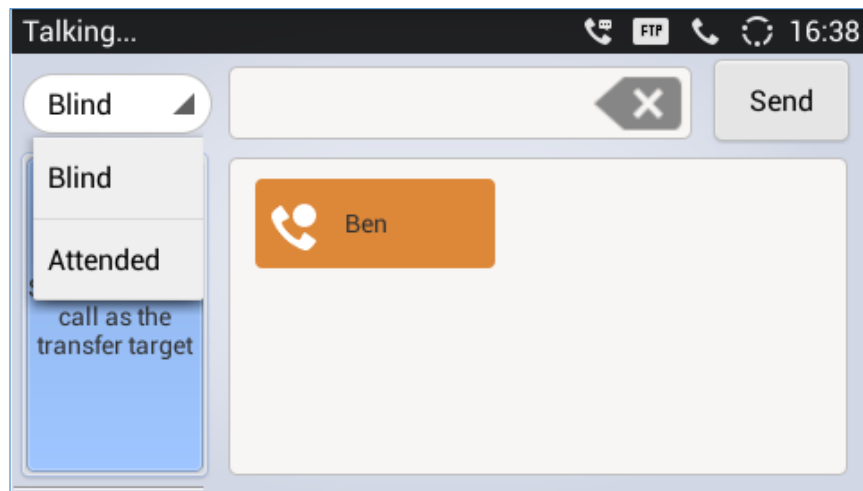
5. After transfer target answers the call, the following screen will be shown up. If the user simply hangs up, taps on "End" or taps on the "Transfer" soft key, the call will be transferred, and GXV3240 will hang up the call. If the user taps on "Split" soft key to separate the calls, the user will talk to the second established call while the first call is on hold.





**Figure 52: Attended Transfer - Split**


6. Besides attended transfers above, users could also consult the third party first before transferring the call.
7. During the active call, tap  on the right panel to make the second call. This will place the current call on hold;
8. The second call establishes after the call is answered;
9. Press TRANSFER button  to bring up transfer screen. The first call on hold will be displayed such as ;
10. Select transfer mode as "Attended" in the transfer screen and tap on button such as  to transfer the call;
11. The call will be transferred, and GXV3240 will hang up the call.



**Figure 53: Attended Transfer**

---

 **Note:**

- To transfer calls across SIP domains, SIP service providers must support transfer across SIP domains;
  - If users would like to cancel the transfer, press  button to go back to the previous talking screen.
- 

## 6-Way Conference

The GXV3240 supports up to 6-way audio conferencing.

### Initiate Conference



1. When the phone is in idle, call screen, or during an active call, press CONFERENCE button  to bring up conference screen; users could also press CONF button in call screen right after off hook the phone;
2. Tap on  to start adding party in conference;



Figure 54: GXV3240 Conference Screen

3. Enter the number of the party and tap on "Invite" to add it to the conference.



Figure 55: GXV3240 Conference - Add New Call to the Conference

If there are calls on hold, they will show up when adding member to the conference. Users could then tap on the call to add it to the conference directly.

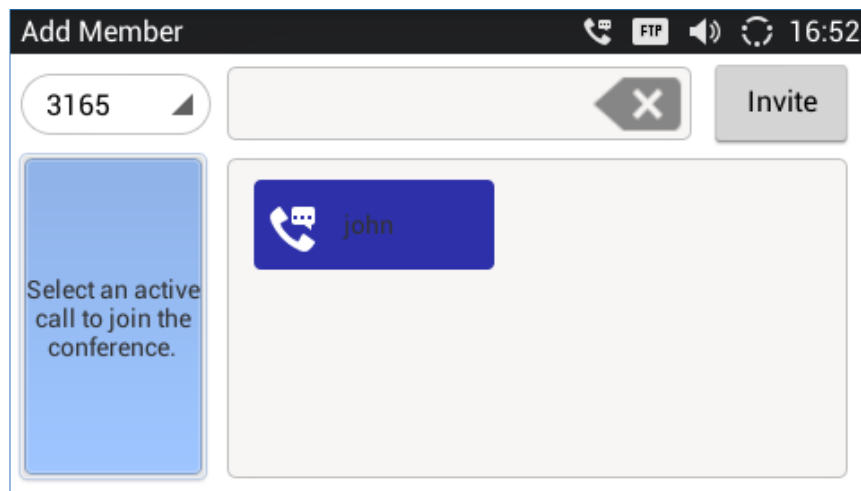


Figure 56: GXV3240 Conference - Add Existing Call to Conference

- Repeat the above steps to add more parties into the conference. The following figure shows a 4-way conference established.



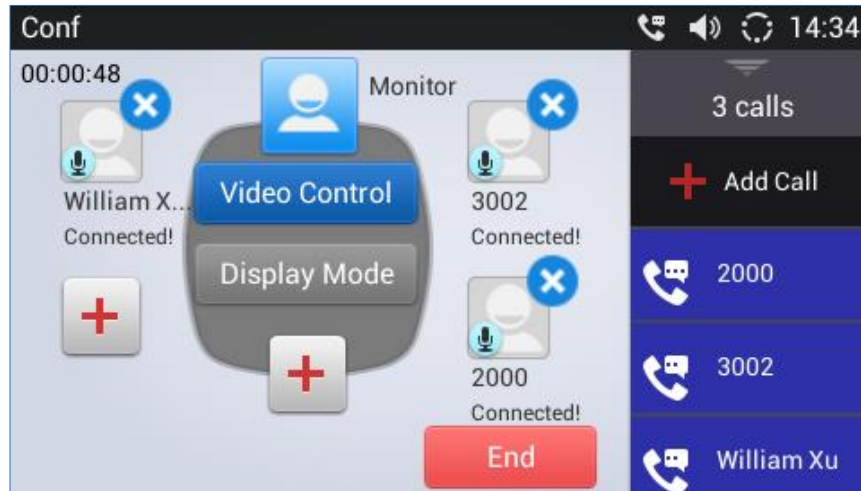




Figure 57: 4-way Conference Call Established


### Remove Party from Conference

To remove a party from the conference, tap  on the right top corner for the corresponding party. This party will be disconnected from the conference.


### End Conference

To end the conference, tap on  to disconnect all the parties from the conference. GXV3240 will hang up the call. If the remote party hangs up the call itself, it will be disconnected from the conference but other parties on GXV3240 will stay in the existed conference.

### Hold and Resume Conference

During the conference, users could press the HOLD button  to hold or resume the conference at any time.

### Auto Conference Mode

The GXV3240 also supports "Auto Conference" which allows users to establish conference call in a quick and easy way, instead of adding the other parties one by one. To enable Auto Conference feature, go to web GUI->**Advanced Settings**->**Call Features** and set "**Auto Conference**" to "Yes". To establish call with auto conference when there are 1 or more calls on the GXV3240, simply press the conference button  and all the calls on GXV3240 will be brought into the conference.

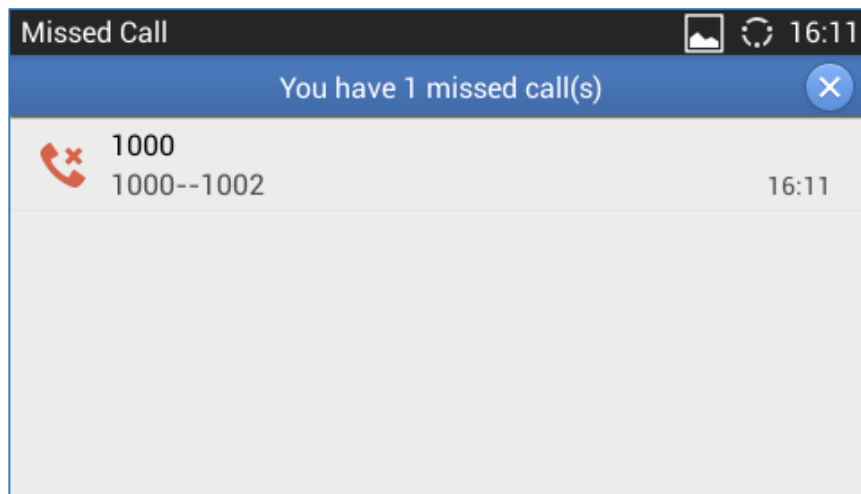


 **Note:**


- During the conference, if the initiator of the conference hangs up, the conference will end. If users wish to allow the remaining parties to stay in conversation after the initiator hangs up, the conference initiator should set "Transfer on 3-way Conference Hang up" to "Yes" in web GUI->**Account** page->**Call Settings**. This would allow the remaining parties to stay in the conference after the initiator exists the conference.

## Missed Call

When there is a missed call, the LCD will show missed call dialog on the idle screen.



**Figure 58: Missed Call Screen**

Users can tap on the one of missed call entry to access the missed call log. To close the missed call screen and return to the idle screen, tap  on the upper right.




**Note:** Users may also disable the prompt for missed calls on web UI. Users may go to web UI -> Account -> Call Settings -> Call Log, users need to choose "Don't Prompt Missed Call" to disable the prompt for missed call logs.

## DND (Do Not Disturb)

When DND is on, the incoming calls to the GXV3240 will be blocked for all registered accounts with a reminder ring produced.

To turn on/off DND:

1. Touch and drag the status bar down on the GXV3240 idle screen. Then tap on "**System Settings**".

2. Tap on the DND icon  to turn it on. The status bar shows icon  indicating DND is on.
3. Tap on the DND icon  to turn it off.

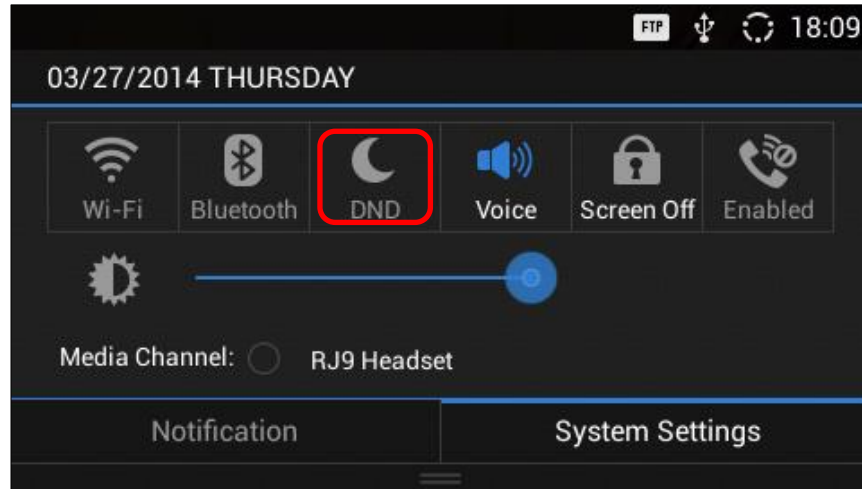



Figure 59: Enable/Disable DND


 **Note:**

- When the phone is in an active call, turning on/off DND won't affect the current active call. It will take effect starting from the next incoming call.
- When the DND is on, all the incoming call logs will be saved in Blacklist. They won't be saved in Call History.

## Voicemail/Message Waiting Indication

When there is a new voicemail, the Message Waiting Indication (MWI) LED icon will blink in red on the upper right corner of the GXV3240 and  will show up in the status bar.

To retrieve the voicemail:

1. Press the Message button  and voicemail screen will show up, with all the registered accounts and the number of voicemails displayed.
2. Tap on the account to dial into the voicemail box. Then follow the Interactive Voice Response (IVR) for the message retrieval process.

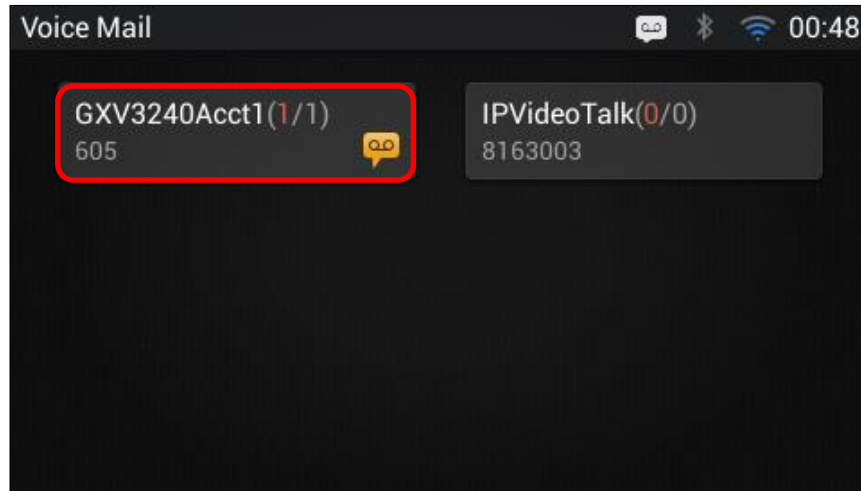


Figure 60: Retrieve Voicemail

For each account, the Voicemail User ID can be set up under web GUI->**Account X**->**General Settings**: "Voice Mail UserID". This is the number that will be dialed out to access voicemail message when tapping on the account in Voice Mail screen.

## Call Forward

Call forward feature can be set up from GXV3240 LCD or web GUI.

- **From LCD**

Go to onscreen Menu->**Settings**->**Personalized Account**->Select account name and tap on **Call Forwarding** to activate the feature. Then a list of options will show. Select the option to configure the call forward type (None, Unconditional, Time Based, Others) and then enter necessary number in the fields.

- **From Web GUI**

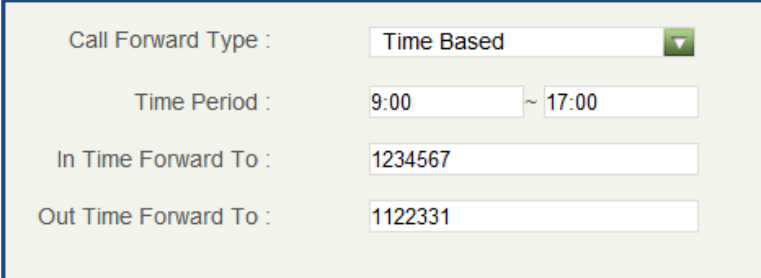
Log in GXV3240 web GUI and go to **Account** page->**Call Settings**. By default, Call Forward feature is set to "None". The Call Forward feature options are:

- **Unconditional Forward:** All the incoming calls will be forwarded to the number set up in "All To" field.

Figure 61: Call Forward - Unconditional



- **Time Based Forward:** All the incoming calls will be forwarded to the number as schedule in the time period. During the setup time, the call will be forwarded to the number in "In Time Forward To:" field. Other period the call will be forwarded to the number in "Out Time Forward To:" field.



Call Forward Type : Time Based

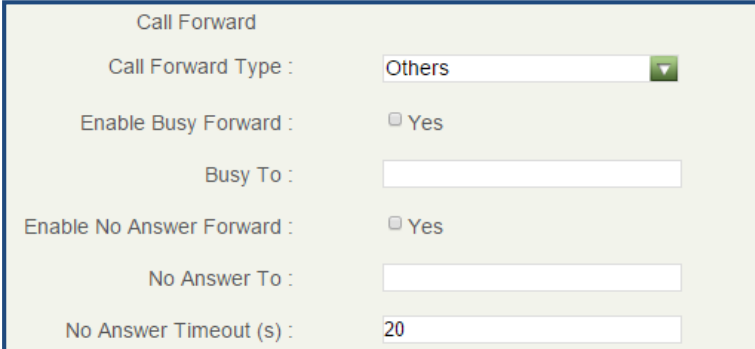
Time Period : 9:00 ~ 17:00

In Time Forward To : 1234567

Out Time Forward To : 1122331

Figure 62: Call Forward - Time Based

- **Call Forward on Busy / Call Forward No Answer:** The incoming call will be forwarded when the GXV3240 is busy or no answer after certain interval "Delayed Call Forward Wait Time (s)".



Call Forward

Call Forward Type : Others

Enable Busy Forward :  Yes

Busy To :


Enable No Answer Forward :  Yes

No Answer To :



No Answer Timeout (s) : 20

Figure 63: Call Forward - Busy/No Answer

## Multi-Purpose Keys

The GXV3240 supports multi-purpose keys (MPK) without extension board (GXP2200EXT) by downloading MPK app from GS Market. After downloading the MPK app, users could configure the MPK from MPK settings via LCD Menu->MPK app , or via web GUI->**Advanced Settings**->**MPK LCD Settings**.

To configure MPK via MPK app on the GXV3240:

1. Download MPK app from GS Market and install it to the GXV3240.
2. Open the MPK app. Tap  on the upper right of the app and then tap on  to start adding MPK numbers.



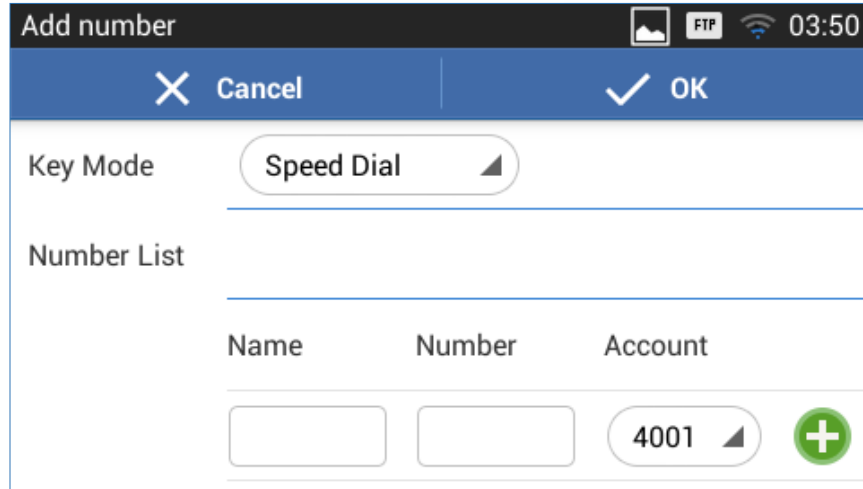


Figure 64: GXV3240 MPK APP - Add Number

- For the number list, users could manually enter it or select number from Contacts to add it.

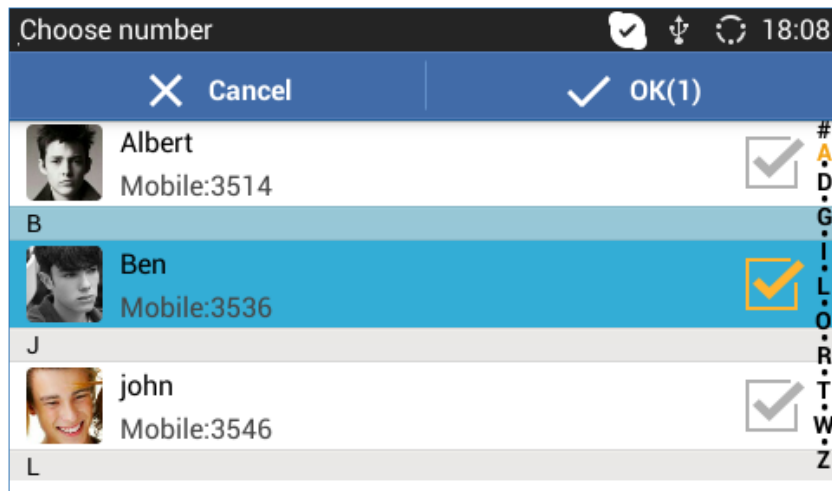


Figure 65: GXV3240 MPK APP - Add Number from Contacts

- The added number will show in the list as the figure shows below.



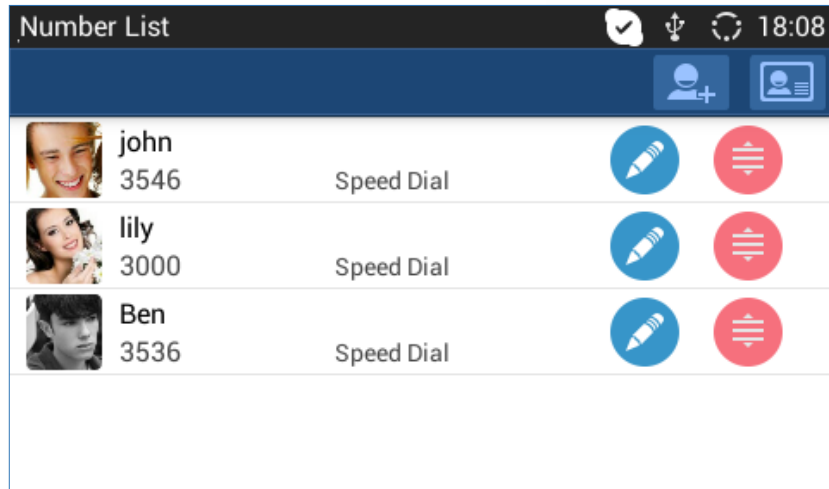


Figure 66: GXV3240 MPK APP - Number List

## Shared Call Appearance (SCA)

The GXV3240 supports shared call appearance by Broadsoft standard. This feature allows members of the SCA group to share SIP lines and provides status monitoring (idle, active, progressing, hold) of the shared lines. When there is an incoming call designated for the SCA group, all of the members of the group will be notified of an incoming call and will be able to answer the call from the phone with the SCA extension registered.

All the users that belong to the same SCA group will be notified by visual indicator when a user seizes the line and places an outgoing call, and all the users of this group will not be able to seize the line until the line goes back to an idle state or when the call is placed on hold (with the exception of when multiple call appearances are enabled on the server side).

In the middle of the conversation, there are two types of hold: Public Hold and Private Hold. When a member of the group places the call on public hold, the other users of the SCA group will be notified of this by the yellow-flashing button and they will be able to resume the call from their phone by pressing the line button. However, if this call is placed on private-hold, no other member of the SCA group will be able to resume that call.

To enable shared call appearance, the user would need to register the shared line account on the phone. In addition, they would need to enable SCA and configure SCA options via LCD or web GUI.

To configure SCA via LCD, go to **Settings->Personalized Account** and select one account first. Then tap on "Shared Call Appearance (SCA)" to turn it on.



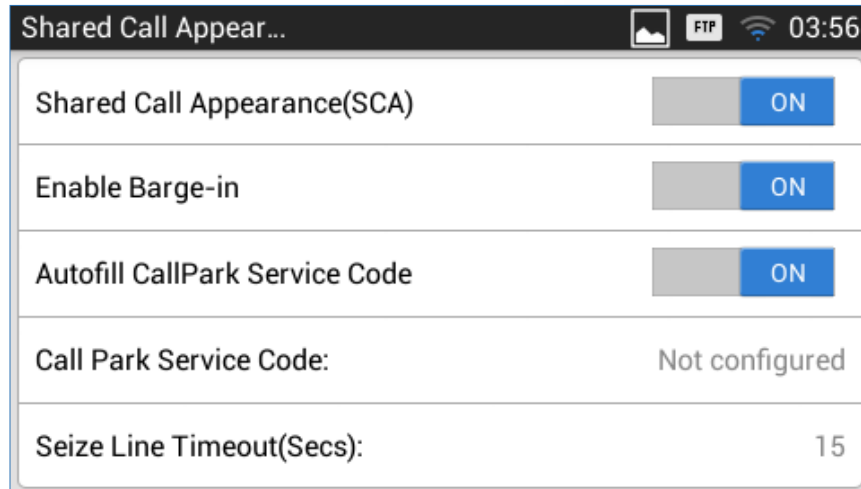


Figure 67: GXV3240 SCA Settings on LCD

To configure SCA via web GUI, go to **Account** page->**SIP Settings** to fill out the options in the following figure.

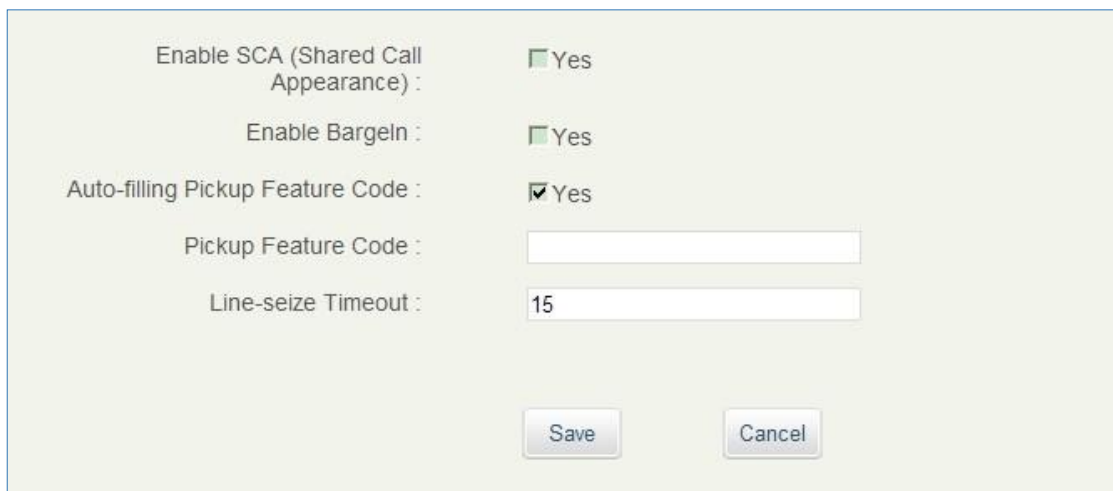


Figure 68: GXV3240 SCA Settings on Web UI

For more information about SCA configuration and function, please refer to the link below:

[http://www.grandstream.com/sites/default/files/Resources/GXV32xx\\_broadworks\\_SCA\\_Guide\\_0.pdf](http://www.grandstream.com/sites/default/files/Resources/GXV32xx_broadworks_SCA_Guide_0.pdf)



## Call Features

The GXV3240 supports traditional and advanced telephony features including caller ID, caller ID with caller Name, call waiting, call forward and etc. Before using the following feature code, please make sure "Enable Call Features" option is set to "Yes" under web GUI->**Account** page->**Call Settings**.

**Table 9: GXV3240 Feature Code**

<b>*01</b>	<p><b>Use Preferred Codec</b> (per call)</p> <ul style="list-style-type: none"> <li>• Dial *01 followed by the preferred codec code and the phone number.</li> <li>• The phone will try to use this codec during the call.</li> <li>• Codec code:            PCMU: 7110            PCMA: 7111            G726-32: 72632            G722: 722            G729: 729            iLBC: 7201</li> </ul> <p>For example, if the user would like to use PCMA as the preferred codec to call phone number 334455, enter *017111334455.</p>
<b>*02</b>	<p><b>Force Codec</b> (per call)</p> <ul style="list-style-type: none"> <li>• Dial *02 followed by the preferred codec code and the phone number.</li> <li>• The phone will be forced to use this codec during the call.</li> <li>• Codec code:            PCMU: 7110            PCMA: 7111            G726-32: 72632            G722: 722            G729: 729            iLBC: 7201</li> </ul> <p>For example, if the user would like to use PCMA to call phone number 334455, enter *017111334455.</p>
<b>*30</b>	<p><b>Block Caller ID</b> (for all subsequent calls)</p> <ul style="list-style-type: none"> <li>• Dial *30.</li> </ul>
<b>*31</b>	<p><b>Send Caller ID</b> (for all subsequent calls)</p> <ul style="list-style-type: none"> <li>• Dial *31.</li> </ul>



<b>*50</b>	<b>Disable Call Waiting</b> <ul style="list-style-type: none"> <li>Dial *50.</li> </ul>
<b>*51</b>	<b>Enable Call Waiting</b> <ul style="list-style-type: none"> <li>Dial *51.</li> </ul>
<b>*67</b>	<b>Block Caller ID (per call)</b> <ul style="list-style-type: none"> <li>Dial *67 followed by the phone number.</li> </ul>
<b>*82</b>	<b>Send Caller ID (per call)</b> <ul style="list-style-type: none"> <li>Dial *82 followed by the phone number.</li> </ul>
<b>*70</b>	<b>Disable Call Waiting (per Call)</b> <ul style="list-style-type: none"> <li>Dial *70 followed by the phone number.</li> </ul>
<b>*71</b>	<b>Enable Call Waiting (per Call)</b> <ul style="list-style-type: none"> <li>Dial *71 followed by the phone number.</li> </ul>
<b>*72</b>	<b>Unconditional Call Forward.</b> To set up unconditional call forward: <ul style="list-style-type: none"> <li>Dial *72 followed by the phone number to forward the call.</li> </ul>
<b>*73</b>	<b>Cancel Unconditional Call Forward.</b> To cancel the unconditional call forward: <ul style="list-style-type: none"> <li>Dial *73.</li> </ul>
<b>*74</b>	<b>Paging Call</b> <ul style="list-style-type: none"> <li>Dial *74 followed by the phone number to send the paging call.</li> </ul>
<b>*83</b>	<b>Force Audio Calling (per call)</b> <ul style="list-style-type: none"> <li>Dial *83 followed by the phone number to send the audio call.</li> </ul>
<b>*84</b>	<b>Force Video Calling (per call)</b> <ul style="list-style-type: none"> <li>Dial *84 followed by the phone number to send the video call.</li> </ul>
<b>*90</b>	<b>Busy Call Forward.</b> To set up busy call forward: <ul style="list-style-type: none"> <li>Dial *90 followed by the phone number to forward the call.</li> </ul>
<b>*91</b>	<b>Cancel Busy Call Forward.</b> To cancel the busy call forward: <ul style="list-style-type: none"> <li>Dial *91.</li> </ul>
<b>*92</b>	<b>Delayed Call Forward.</b> To set up delayed call forward: <ul style="list-style-type: none"> <li>Dial *92 followed by the number to forward the call. The default timeout before the call is forwarded is 20 seconds.</li> </ul>



**\*93**

**Cancel Delayed Call Forward.** To cancel the delayed call forward:




- Dial \*93.



## CONTACTS

Users can manage contacts by adding, deleting and modifying single contacts, downloading contacts from HTTP/HTTPS/TFTP server, importing contacts from external storage and exporting contacts to external storage.

There are three ways to access GXV3240 contacts:

- On the keypad, press  button.
- On the phone's idle screen or menu, open Contacts app by tapping on icon .
- On the phone's idle screen or menu screen, tap on icon  on the bottom of the screen.

The following figure shows main page of Contacts on the GXV3240.

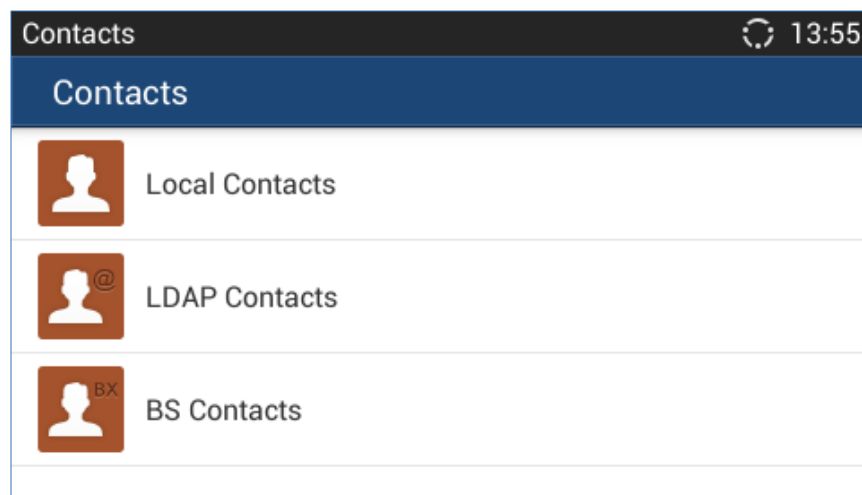


Figure 69: GXV3240 Contacts

Tap the icon to access the main page of Contacts. The LDAP Contacts includes the contacts in specific LDAP server, and BS Contacts includes the BroadWorks Xsi Contacts. They need to be configured with the remote LDAP server or BroadWorks server to enable these features.

**Note:** Users could set the “Phonebook Key Function” on phone’s Web UI -> **Maintenance** -> **Contacts**. Users could set the phonebook key to “**Default**”, “**LDAP Search**”, “**Local Phonebook**”, “**Local Group**”, and “**BroadSoft Phonebook**”.

### Local Contacts

Users can manage contacts by adding, deleting and modifying single contacts, downloading contacts from



HTTP/HTTPS/TFTP server, importing contacts from external storage and exporting contacts to external storage.

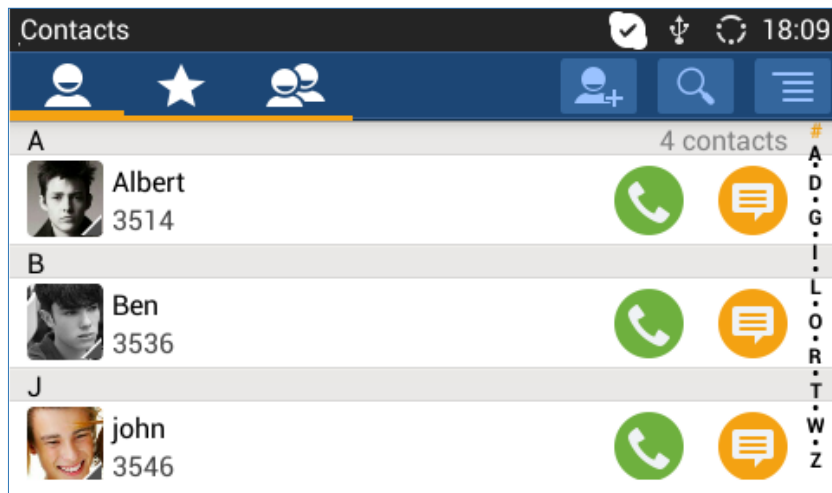







Figure 70: GXV3240 Local Contacts

On the upper left of the Contacts screen, users can tap on the icon to access three different categories in the contacts:

-  All contacts.
-  Favorite Contacts
-  Groups

## Add Single Contacts

1. Tap on  to access all contacts.
2. Tap on  to bring up "New Contact" dialog to manually add a new contact. See [Figure 71: GXV3240 Contacts - Add New Contact].
3. Enter First name, Last name, Phone number and other information for the new contact. Please make sure the account number field is selected so the GXV3240 will use this account to dial out the new contact. The account number field is located on the left of the "Phone" field as highlighted below.



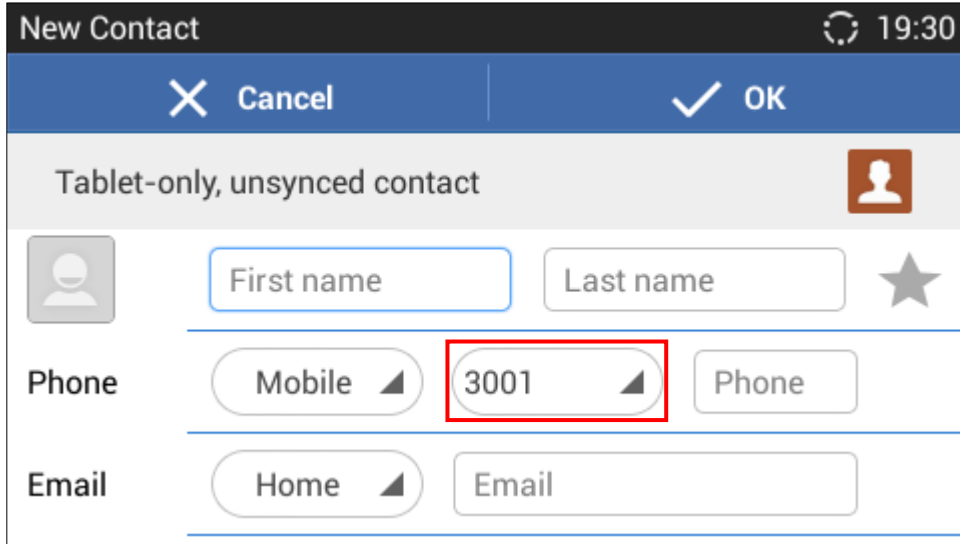



Figure 71: GXV3240 Contacts - Add New Contact

## Import/Export Contacts

If the users have the GXV3240 phonebook file saved in local storage or external storage device that has been plugged into the GXV3240, the phonebook file can be directly imported to the Contacts. There are three different formats supported for the phonebook file: "csv", "vcard", and "xml". Users could manually create contacts first and export the phonebook file in csv, vcard or xml format to take a look on the phonebook file.

### To import contacts:

1. Open Contacts.
2. Tap  on the upper right of the Contacts screen.
3. Select "Import" to bring up "Import Contacts" dialog.



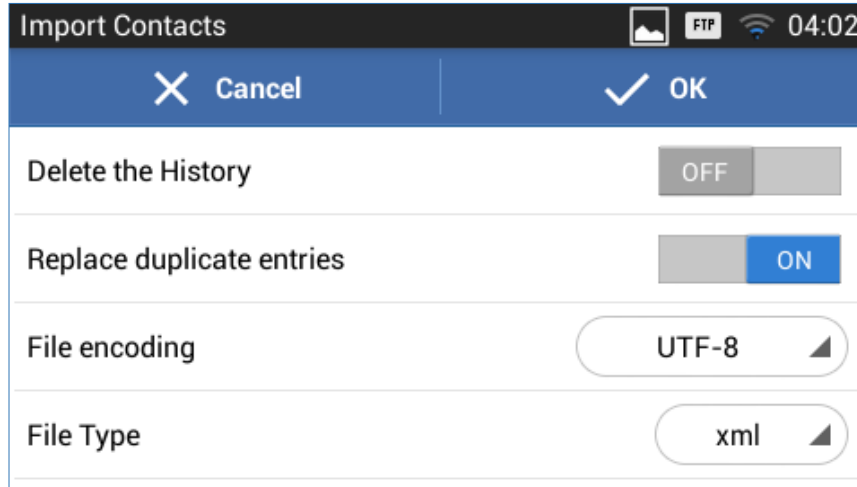



Figure 72: GXV3240 Contacts - Import Contacts

4. Fill in the import options and scroll down to the bottom of the screen.
5. Tap on "Select the file" to import phonebook file from the directory in internal or external storage device.

**To export contacts:**

1. Open Contacts.
2. Tap on  on the upper right of the Contacts screen.
3. Select "Export" to bring up "Export Contacts" dialog.

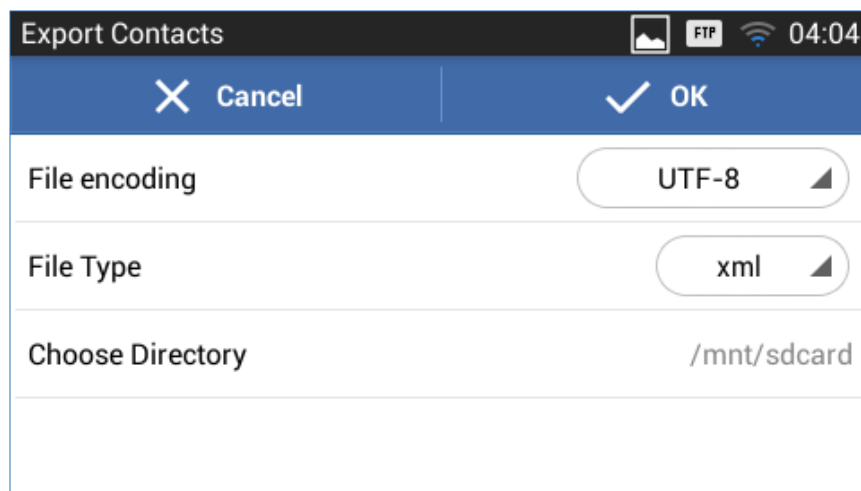


Figure 73: GXV3240 Contacts - Export Contacts

4. Select the file encoding and file type for the exported phonebook file. By default, the GXV3240 is using "UTF-8" as the encoding method.
5. Tap on "Choose Directory" and select the directory where the phonebook file will be exported to.




## Download Contacts

The GXV3240 supports downloading XML phonebook from a remote HTTP/HTTPS/TFTP server to local Contacts. When downloading the phonebook, the GXV3240 sends request to the HTTP/HTTPS/TFTP server looking for file **phonebook.xml**. For more details about GXV3240 phonebook, please refer to the following link:

[http://www.grandstream.com/products/gxv\\_series/gxv3240/documents/gxv3240\\_xml\\_phonebook\\_guide.pdf](http://www.grandstream.com/products/gxv_series/gxv3240/documents/gxv3240_xml_phonebook_guide.pdf)

To download phonebook:

1. Make sure the GXV3240 can connect to the HTTP/HTTPS/TFTP server and the phonebook.xml file in correct format is downloadable from the HTTP/HTTPS/TFTP server.
2. Open Contacts.
3. Tap  on the upper right of the Contacts screen.
4. Select "Download" to bring up the "Download Contacts" dialog.

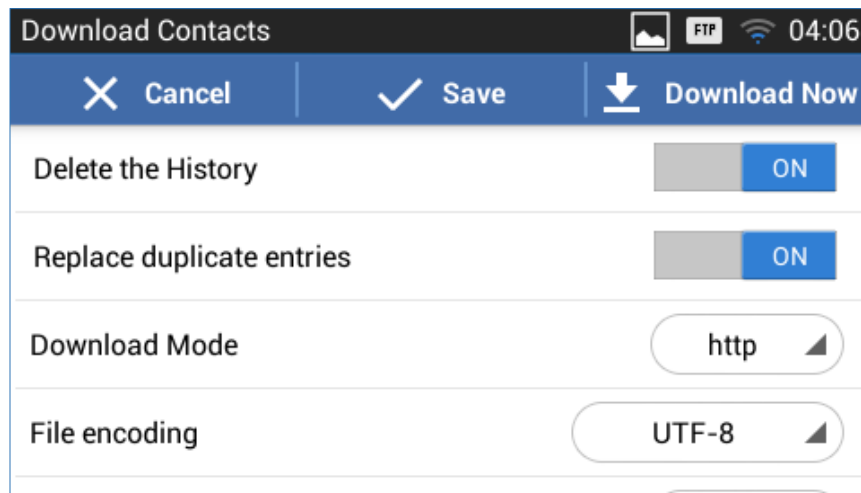





Figure 74: GXV3240 Contacts - Download Contacts


5. Fill in the necessary options and then tap on "Download Now". The GXV3240 will send out request to the configured HTTP/TFTP server.

## Search Contacts


1. Open Contacts.
2. Select  or  to open the contact list where you would like to search.
3. Tap  on the upper right to bring up search dialog.
4. Enter contact's name or number to search. The search result will be automatically updated and displayed when entering the key words.




## Use Contacts

Once the contacts are added, users could navigate in the contacts list  to make a call, send message and manage the contacts further more.


### Make A Call to Contacts

Scroll up/down to find the contact in the list and tap on  to call this contact.

### Send SMS Message to Contacts

Scroll up/down to find the contact in the list and tap on  to call this contact.

### Select Contacts

1. Scroll up/down to find the contact in the list.
2. Touching and pressing on the contact for about 2 seconds until the checkbox shows up.
3. Tap on the checkbox for the contacts to be selected.  indicates the contact is selected.

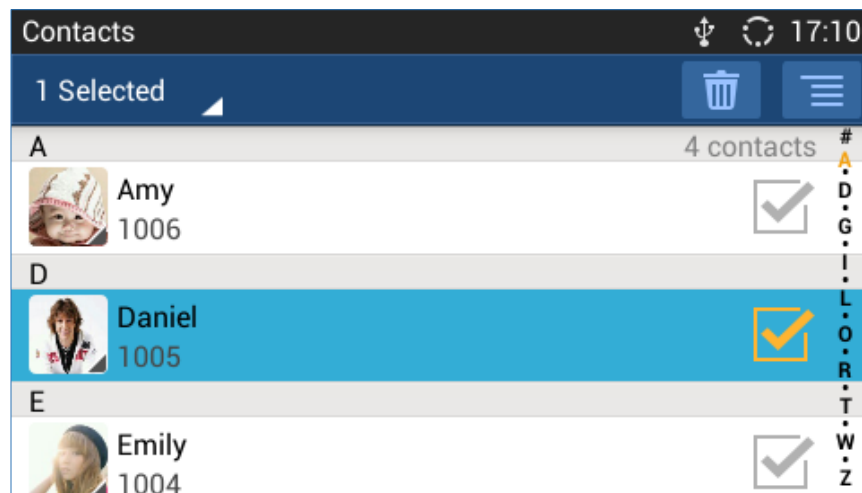



Figure 75: GXV3240 Contacts - Select Contacts

### Add Contacts to Favorites

1. Select the contact to be added as described in [**Select Contacts**].
2. Tap on  and select "Add to favourites".

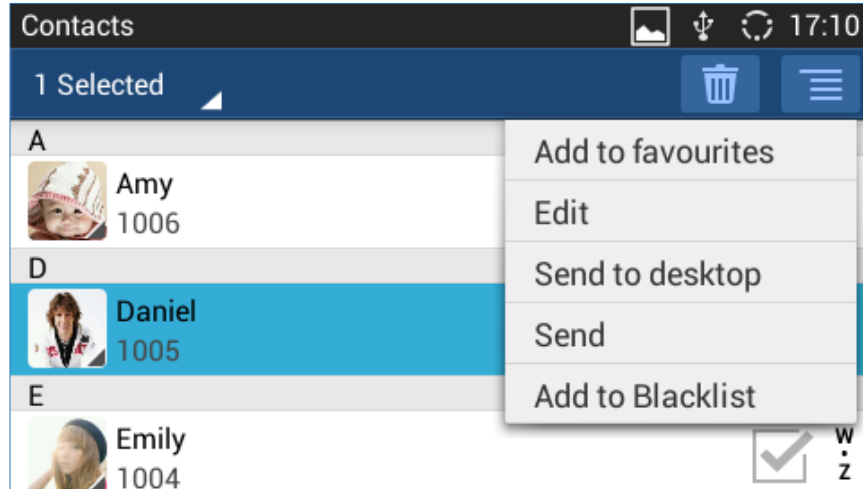





Figure 76: GXV3240 Contacts - Contacts Options

There are another 2 methods to add contacts to favorites.

- When adding or editing single contact, tap on  to add the contact to favorite, or
- Tap on  to navigate to favorite category. Then tap on  to select the contacts to be added to favorites.

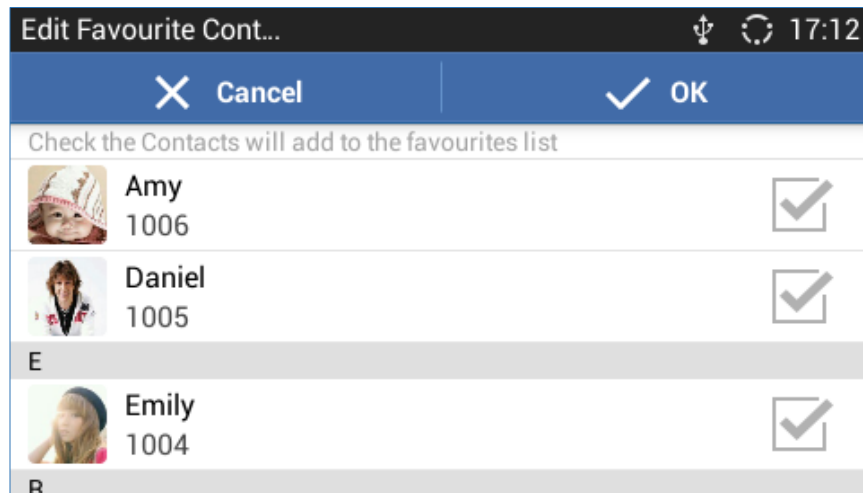




Figure 77: Add Contacts to Favorites

### Edit Contacts


1. Select the contact as described in **[Select Contacts]**.
2. Tap on  to edit the contacts.




### Send Contacts to Desktop Shortcut

1. Select the contact as described in [**Select Contacts**].
2. Tap on  and select "Send to desktop". A shortcut for this contact will be created on the idle screen for the users to access.



### Share Contacts Via Bluetooth

1. Select the contact as described in [**Select Contacts**].
2. Tap on  and select "Send". Users will be able to send this contact to the connected Bluetooth device with the GXV3240.

### Add Contacts to Blacklist

1. Select the contact as described in [**Select Contacts**].
2. Tap on  and select "Add to Blacklist".

### Add Group

Open Contacts and tap on  to access group. To add a new group, tap on  and select the existing contacts to the group.

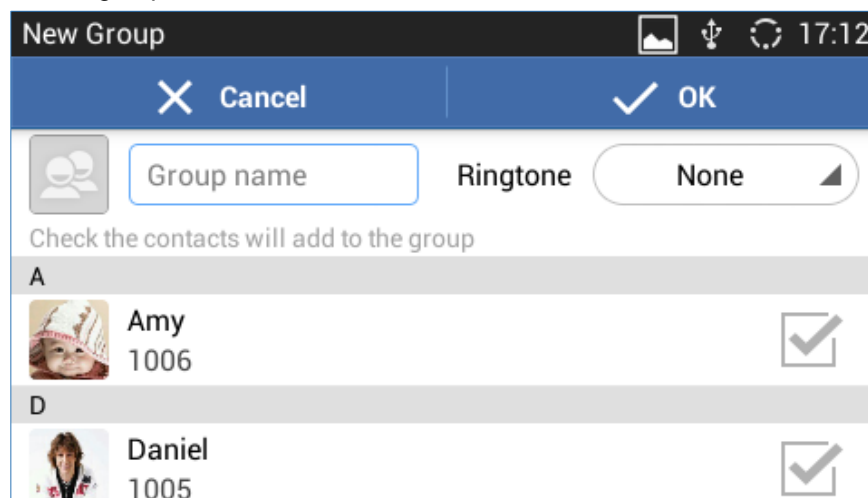


Figure 78: GXV3240 Contacts - Add New Group


#### Note:

- Users could also select group for the contact when adding or editing the contact.
- Ringtone can be assigned in group as well as single contact. If the group has ringtone set to "Custom Ringtone", this ringtone has the highest priority when there is an incoming call to the contact.



## Contacts Storage Status

The GXV3240 default maximum contacts storage is up to 1000. To check contact storage status, tap on

 to bring up contacts options and select "Storage Status".

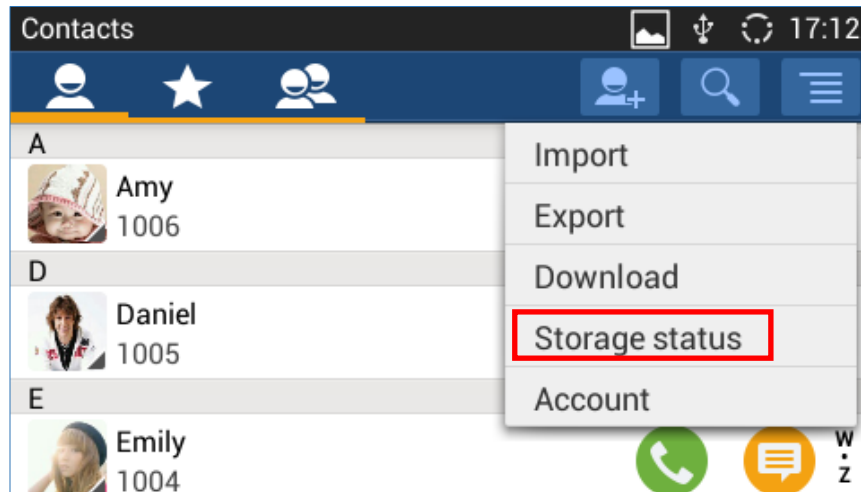


Figure 79: GXV3240 Contacts – Contact Options

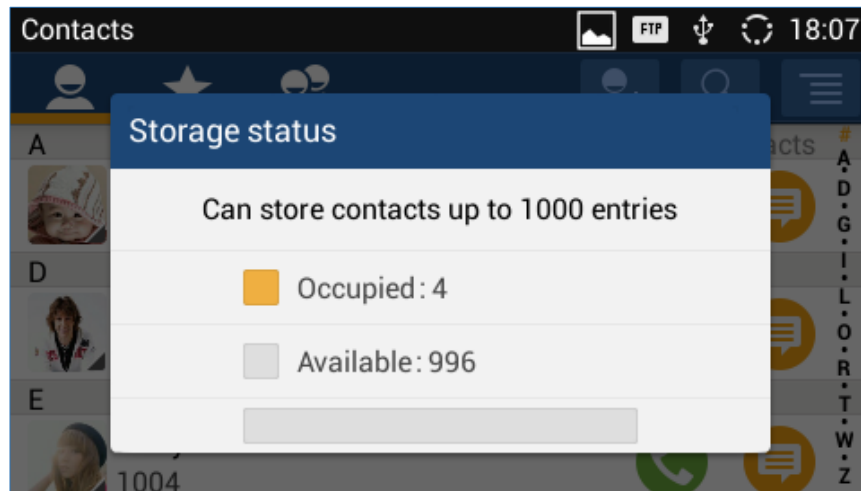


Figure 80: GXV3240 Contacts - Storage Status


**Note:** Users could increase the number of maximum contacts storage to more than 1000 contacts on GXV3240. Users may access the phone through telnet, and change the P value P1688 to another number ( $\leq 10000$ ) to increase the default contacts storage. In this case, if users increase this default P value, the phone resource will be cost, and the phone performance will be slower.

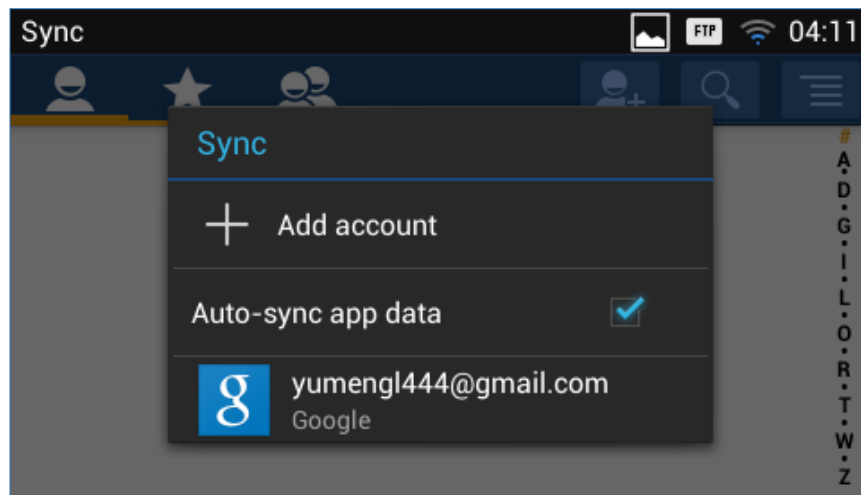
## Add Account to Sync Up Contacts

On the GXV3240, users could add 3rd party application account (e.g., Gmail, Microsoft Lync, Skype, and etc.) so that the contacts there could be added to the GXV3240.



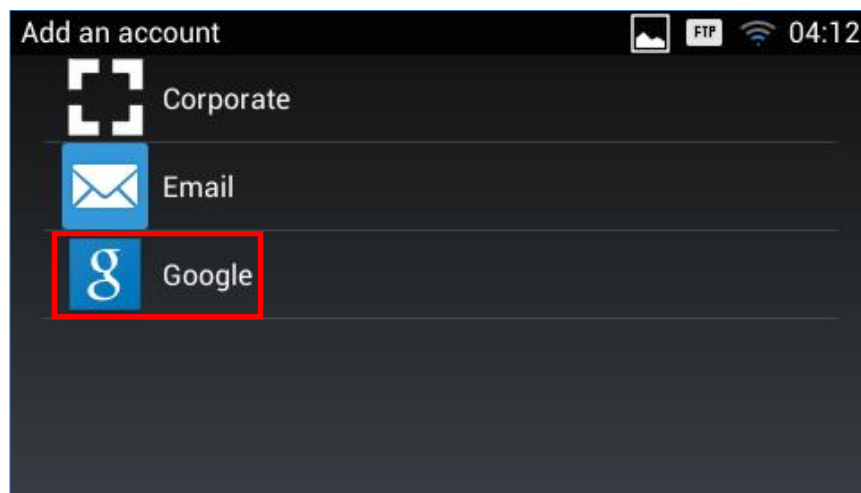
To add 3rd party application account:

1. Make sure the 3rd party application is installed successfully. For example, install Skype from GS market if you would like to add Skype account's contacts to the GXV3240.
2. Open contacts.
3. Tap on  to bring up contacts options and select "Account".



**Figure 81: GXV3240 Contacts Options- Account**

4. An installation wizard will guide the user to set up the account to sync the contacts step by step. Tap on "Add account" if there is no logged-in account set up on the GXV3240 yet.
5. The following figures describe adding a Google account for sync-up purpose. Tap on "Google" to add a Google account.



**Figure 82: Add Account to Sync up in Contacts**

6. Follow the wizard and select "Existing" or "New" for the Google account.

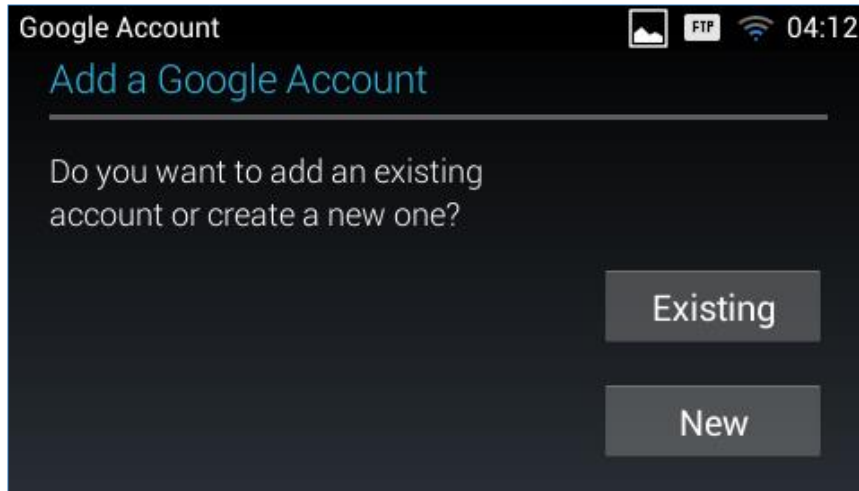


Figure 83: Add Google Account to Sync up in Contacts

If users select "Existing", sign in with the Email address and password to complete the setup.

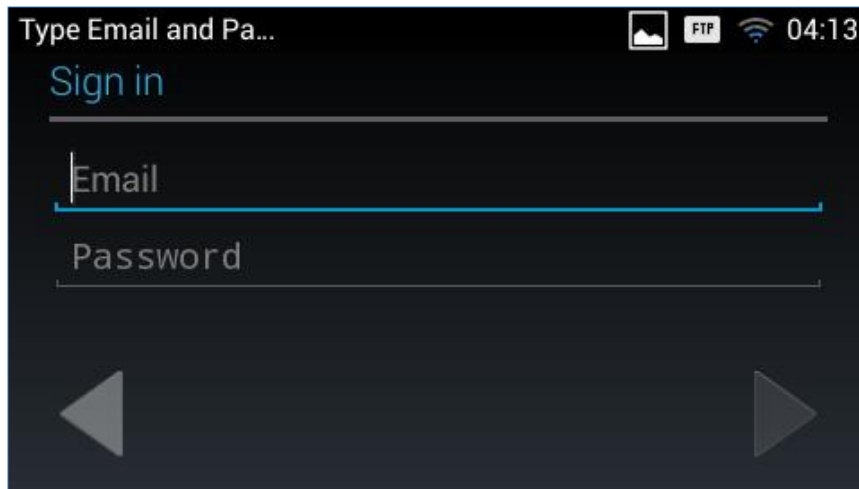


Figure 84: Sign in Google Account



## LDAP PHONEBOOK

In addition to local contacts, the GXV3240 also supports LDAP and LDAPS phonebook if LDAP or LDAPS server is available within the network. Please refer to the following link for more details about how to use LDAP book on the GXV3240:

[http://www.grandstream.com/sites/default/files/Resources/GXV3240\\_ldap\\_book\\_guide\\_0.pdf](http://www.grandstream.com/sites/default/files/Resources/GXV3240_ldap_book_guide_0.pdf)



## **BROADWORKS XSI CONTACTS**

Besides the Local and LDAP phonebook, the GXV3240 also supports BroadWorks Xsi contacts if BroadWorks XSP server is available within the network. Please refer to the following link for more details about how to use BroadWorks Xsi Contacts on the GXV3240:

[http://www.grandstream.com/sites/default/files/Resources/GXV\\_XSI\\_Guide.pdf](http://www.grandstream.com/sites/default/files/Resources/GXV_XSI_Guide.pdf)




## BLACKLIST

The GXV3240 has blacklist support for users to manage incoming calls. To access blacklist, tap on icon





in the phone's menu.

### Block History

Open blacklist and tap on  to view the block history. It shows the detailed information for the blocked calls: caller number, caller name and calling time.

### Restore Blocked Number

The blocked number in the block history can be restored to call history and the number will be removed from blacklist. To do this:

1. In the block history, touch and press the entry for about 2 seconds until checkbox displays.
2. Tap on the checkbox for the entries to be selected.  indicates the entry is selected.
3. Tap on  and select "Restore to Call History".

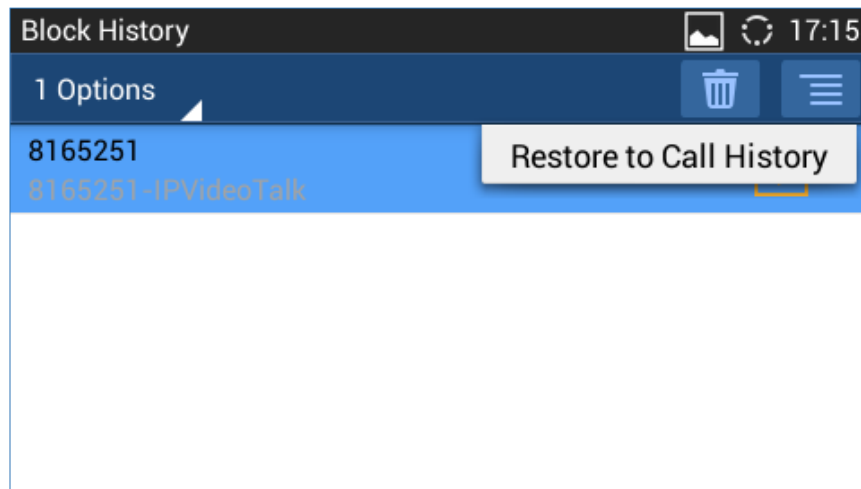





Figure 85: Restore Blocked Number

4. A dialog will pop up for users to confirm. Tap on OK to restore this number to call history and the number will be removed from blacklist.




## Delete Block History


1. In the block history, touch and press the entry for about 2 seconds until checkbox displays.
2. Tap on the checkbox for the entries to be selected.  indicates the entry is selected.
3. Tap on  to delete the selected entries.

Users could also tap on  directly to clear all block history logs.

## Edit Blacklist

Tap on  and users will see all the blacklist numbers.

## Add Blacklist

1. Tap on  to start adding new entry to the blacklist. The blacklist can be added manually, add from contacts, or added from call history.

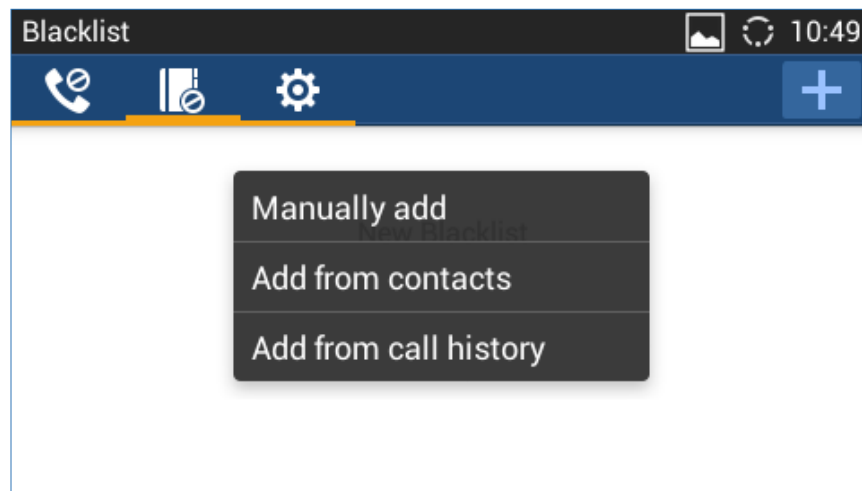


Figure 86: GXV3240 Blacklist - Add Blacklist

2. The following figure shows manually adding number to blacklist. Once **Manually add** option is selected, a window will be prompted for users to enter the phone number in the first field and name/other note information in the second field (optional). Tap on **Save** to finish the adding operation.



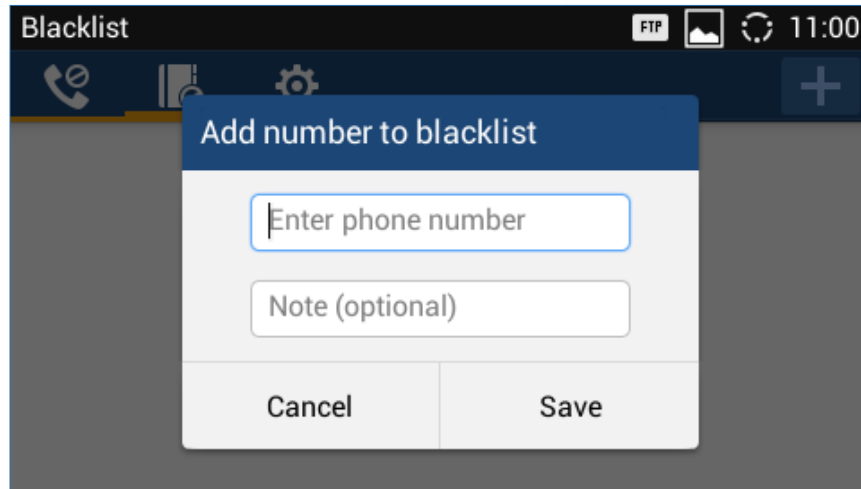



Figure 87: Manually Add Number to Blacklist

### Edit Blacklist

1. In the blacklist, touch and press the entry for about 2 seconds until checkbox displays.
2. Tap on  to edit the blacklist.
3. Tap on OK once done.

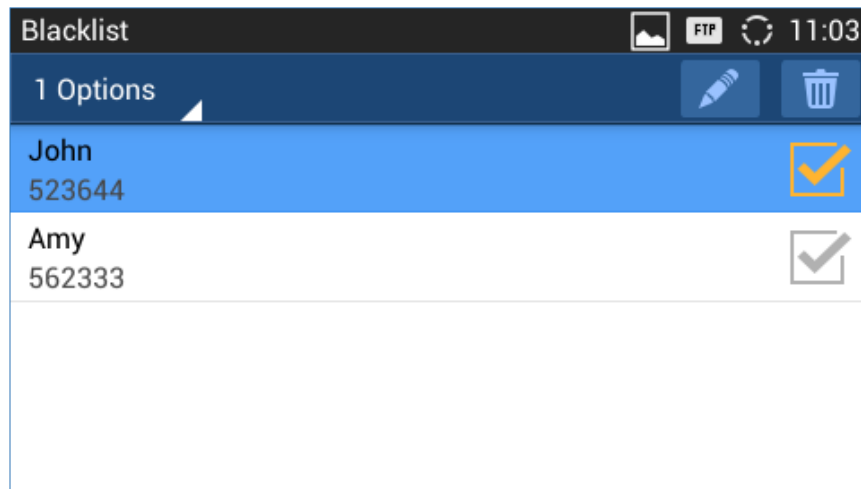





Figure 88: Edit Entry from Blacklist


### Delete Blacklist

1. In the blacklist, touch and press the entry for about 2 seconds until checkbox displays.
2. Tap on the checkbox for the entries to be selected.  indicates the entry is selected.
3. Tap on  to delete the selected entries.



## Blacklist Settings

Tap on  to access blacklist settings.

- **DND Mode:** Turn on/off DND mode. If turned on, all incoming calls will be rejected.
- **Block Mode:** Turn on/off Block Mode. If turned on, the **Block Options** will be activated so that the specific incoming calls will be blocked as defined in **Block Options**.
- **Block Options:** Select **Block All**, **Block Blacklist Only**, **Block Anonymous** or **Block Anonymous And Blacklist**. The option is valid only when **Block Mode** is on;
- **Block Notification:** Turn on/off Block Notification. If turned on, the block icon  will be displayed in the status bar after the phone blocks incoming calls. Users could touch and drag the status bar and tap on the block notification to view details.
- **Time Settings:** Set up the block schedule. Select **Block 24 Hours** or **Modify Time** by specifying the **Starting Time** and **Ending Time**.

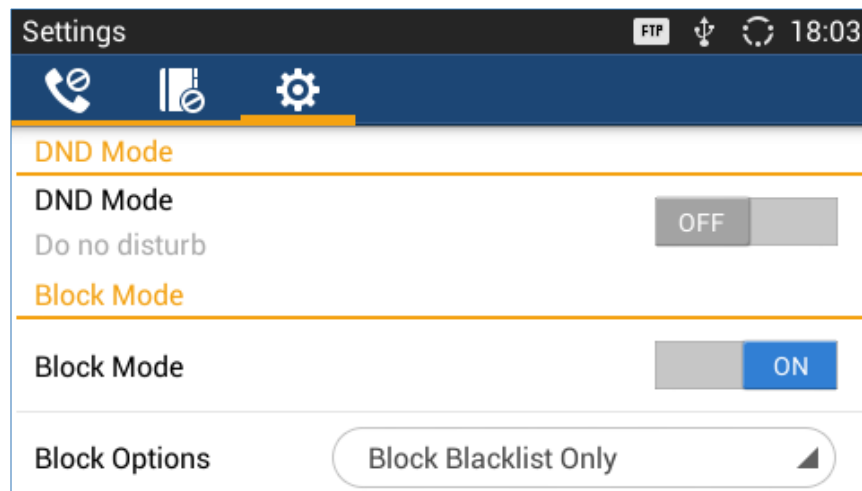




Figure 89: Blacklist Settings



## CALL HISTORY

GXV3240 Call history provides users access to phone's call logs in different categories. Call history can be accessed in the following two ways:

- Tap  on phone's menu or idle screen if call history shortcut is created on the desktop.  
Or
- Tap  on the bottom of the idle screen or menu screen.
- GXV3240 supports local and BroadWorks Xsi call history.

The following figure shows main page of Call History on the GXV3240.

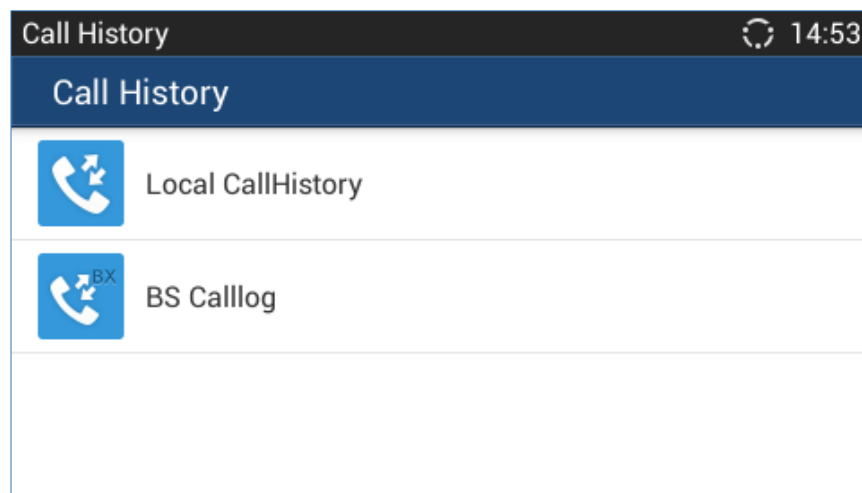

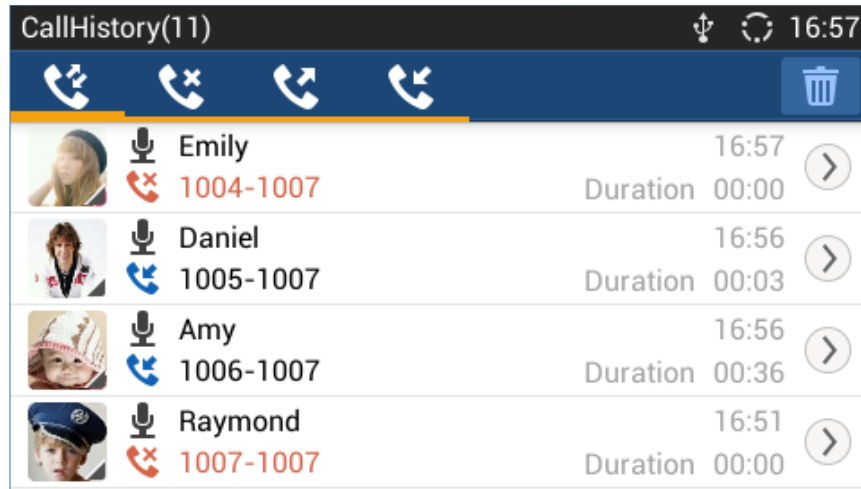


Figure 90: GXV3240 Call History

### Local Call History





Tap the  Local CallHistory icon to enter the local call history.





**Figure 91: GXV3240 Call History**


There are four different categories in the call history. Users could tap on the icon on the top menu to access the corresponding call logs:

-  All calls
-  Answered calls
-  Dialed calls
-  Missed calls

### Dial Out from Call History

Tap on one of the call history entry to call this number directly. The phone will use the same account as the call log when dialing out.

### Call History Options

- Touch and press the call history entry for about 2 seconds until the checkbox displays.
- Then tap on  to bring up the options. Users can edit this number before calling, add this number to contacts, add this number to blacklist and send text message to this number.



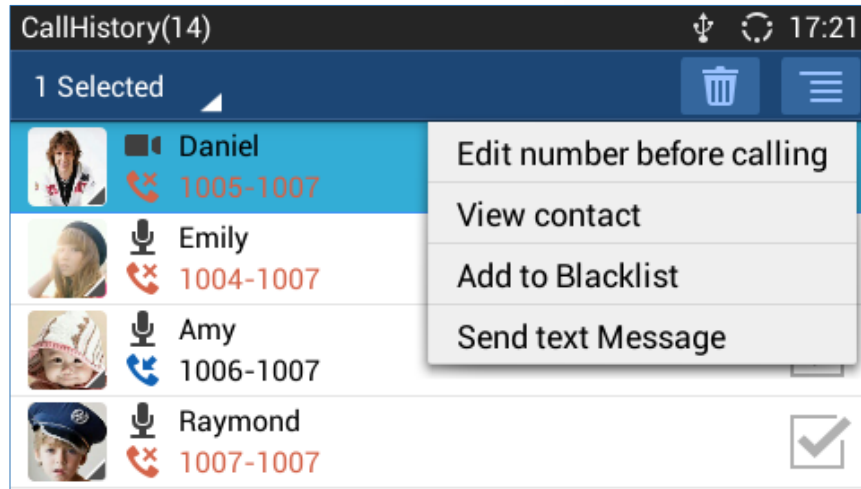




Figure 92: GXV3240 Call History – Options

### Delete Call History

- Touch and press the call history entry for about 2 seconds until the checkbox displays.
- Tap on the checkbox to select the call history entries. The icon turned to  indicates the entry is selected.
- Tap on  to delete the entries.

### Call History Details

For each call history entry, users could tap on  on the right side of the entry to access the details.

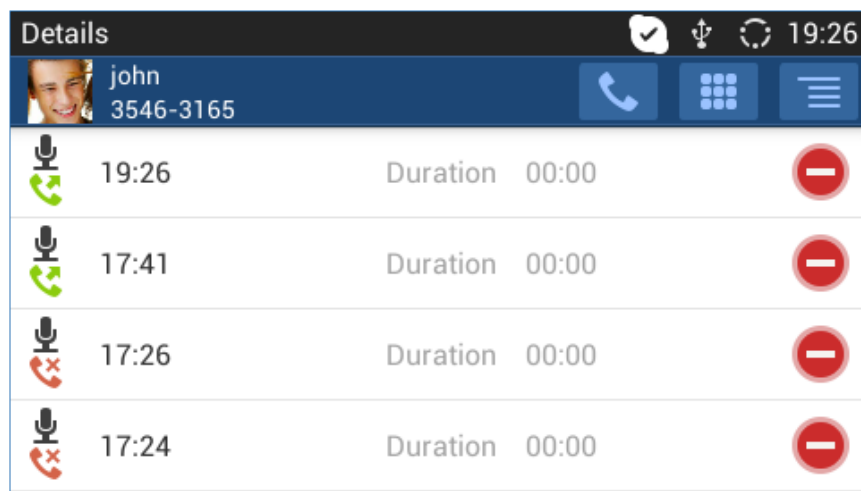






Figure 93: GXV3240 Call History - Details



The following operations could be done:

-  Dial out this number directly.
-  Bring up dial screen with the call history number. Users could edit the number before dialing out.
-  Delete the entry.
-  Options "Clear all", "Add to Contacts", "Add to Blacklist", or "Send Text Message" for the number in this entry.

## **Broadworks XSI Call History**


Besides the Local Call History, the GXV3240 also supports BroadWorks Xsi call history if BroadWorks XSP server is available within the network. Please refer to the following link for more details about how to use BroadWorks Xsi Call History on the GXV3240:

[http://www.grandstream.com/sites/default/files/Resources/GXV\\_XSI\\_Guide.pdf](http://www.grandstream.com/sites/default/files/Resources/GXV_XSI_Guide.pdf)



## SMS

The GXV3240 has built-in SMS application to send/receive message, if the SIP server supports SMS message.

Users can create, edit draft, delete and check the storage status of SMS. The SMS app supports up to 1000 messages. Tap on  on the phone's menu or desktop to launch SMS application.

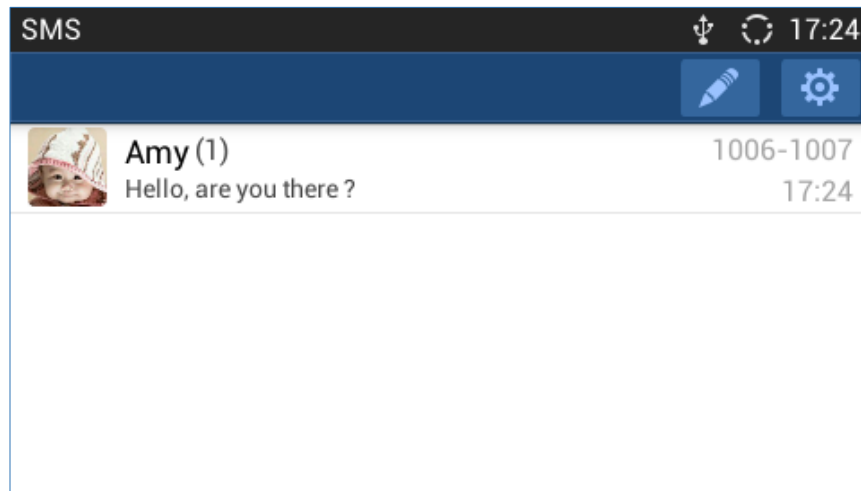


Figure 94: GXV3240 SMS Message

### View SMS

On the SMS list screen, tap on one of the message to view the SMS details.

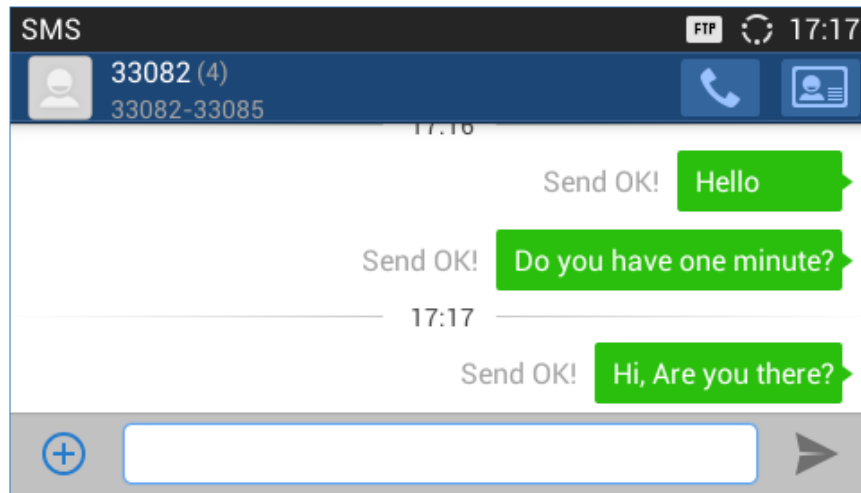



Figure 95: View SMS Dialog



## Create New SMS

Tap on  in SMS application to start composing a new message.

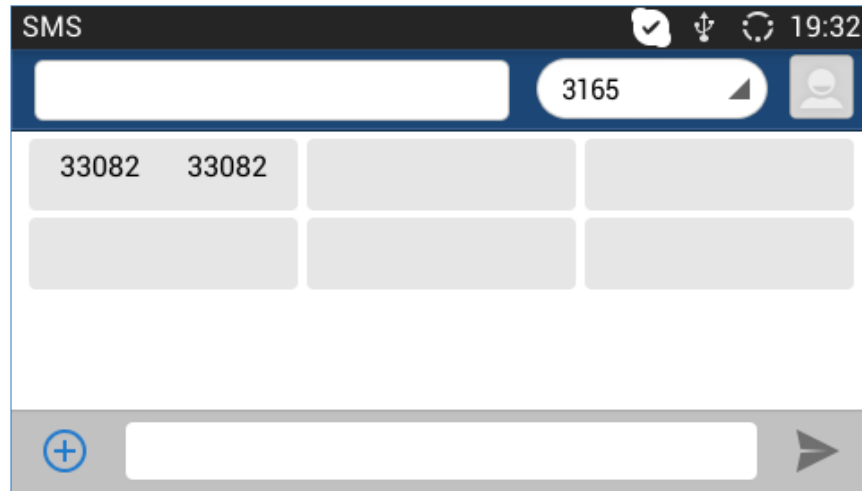






Figure 96: Create New Message

1. Select account to send the message from.  
Select the account to send the SMS message in the drop down box on the right side of the top menu.
2. Add number to send the message to.  
Enter the number of the contact to send the message to on the left side of the top menu. Users could also select contact from GXV3240 Contacts by tapping on . Select the account to send the SMS message in the drop down box on the right side of the top menu.
3. Input content  
Enter the message content on the bottom field of the screen. Tap on "Done" once finished.
4. Send message  
Tap on the arrow icon  when you are ready to send the message out.

## Delete SMS

1. Touch and press one SMS message for about 2 seconds until the checkbox shows.
2. Select the checkbox for the messages to be deleted. Users could also tap on  to select/unselect all message.
3. Tap on  to delete the selected messages.



## CALENDAR

In Calendar application, users could synchronize events from Google account as well as create, modify and view the events. The GXV3240 also provides notification for the upcoming events from the Calendar.

Tap on  to launch Calendar application.

### Sign in Calendar

While launching the Calendar application for the first time, the users will be required to sign in with a Google account.

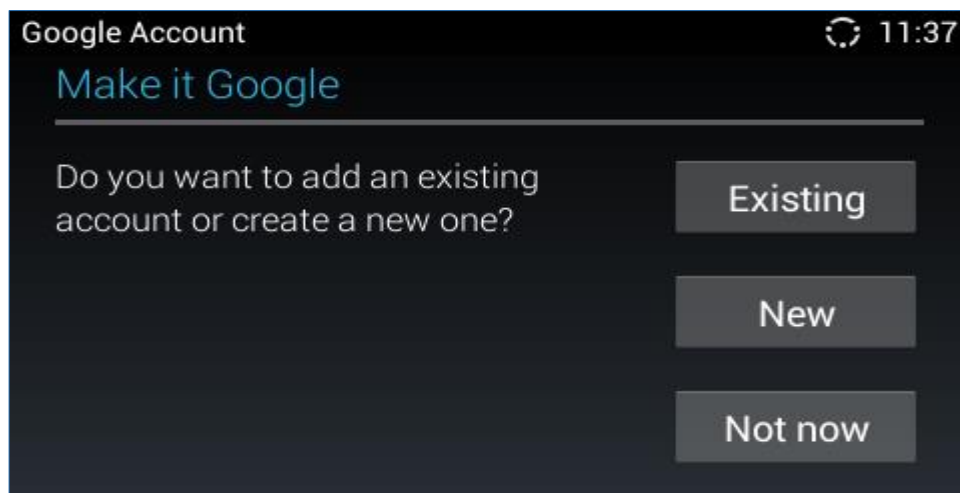


Figure 97: Sign In Calendar with Google Account

### View Calendar

Once signed in, tap on the upper left softkey in the Calendar application to select different format to view the calendar. Users can select "Day" "Week" "Month" or "Agenda" from there.

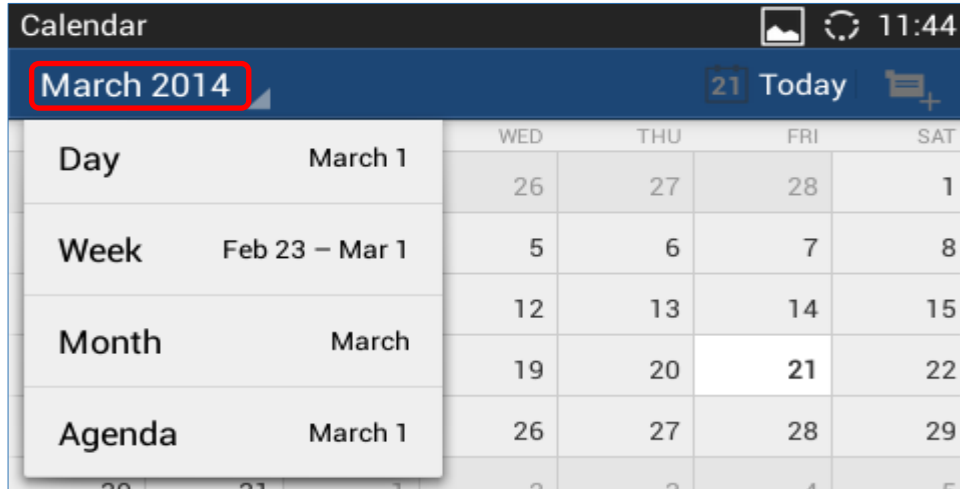


Figure 98: View Calendar

When viewing the calendar by month, the blue mark on the date indicates there is event scheduled on that day. Tapping on it can view the scheduled event.

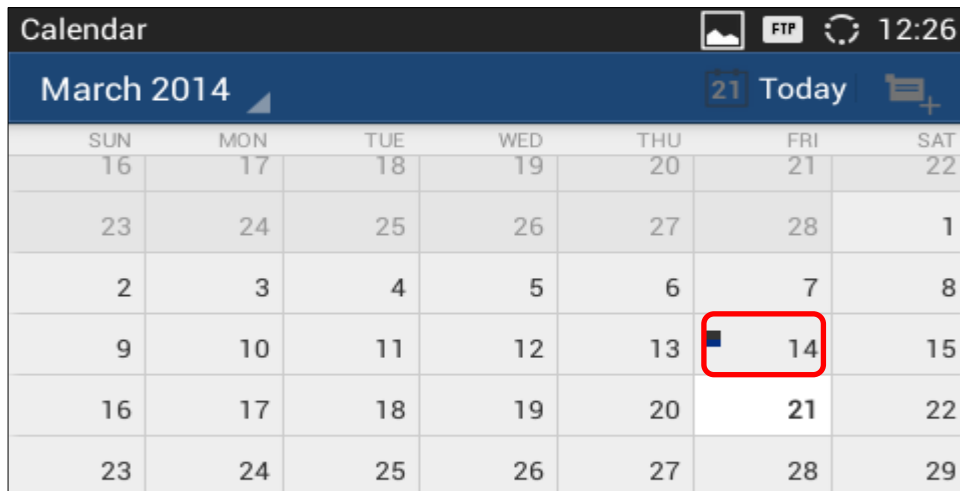


Figure 99: View Calendar by Month



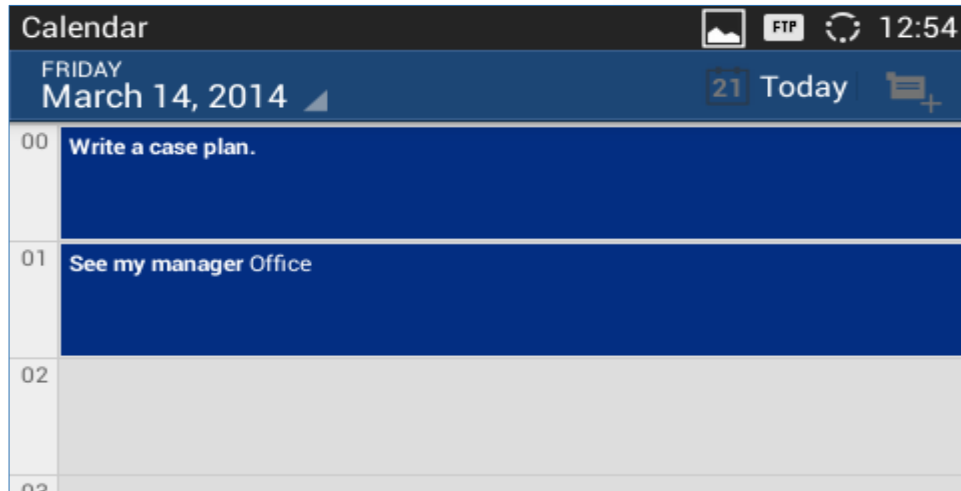



Figure 100: View Calendar by Day

## Create Event

1. Tap on a date in the Calendar application to bring up the event list for that day.
2. On the upper right, tap on  to create a new event.

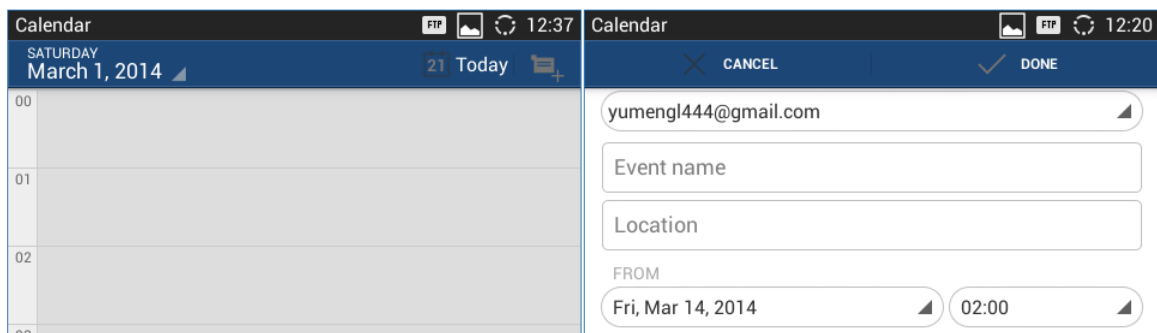



Figure 101: Create Event

## Calendar Options

In the Calendar application, press MENU button  to bring up calendar options. Users could refresh calendar, search events and synchronize calendar with Google account by tapping on "Settings".



## EMAIL

GXV3240 provides built-in Email application for users to access personal or business Email account. Tap on  to launch Email application.

### Sign in Email

When launching the Email application for the first time, a wizard will be provided for users to set up the Email account step by step.

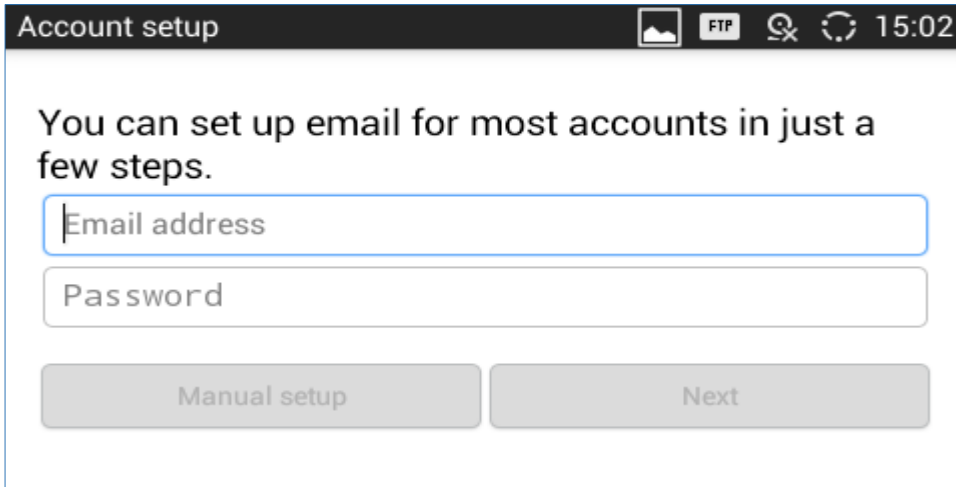
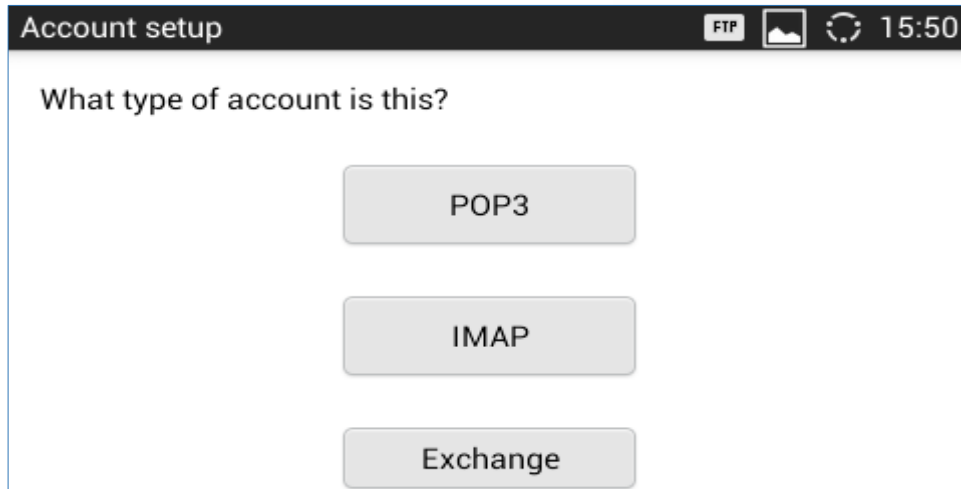


Figure 102: Sign in Email

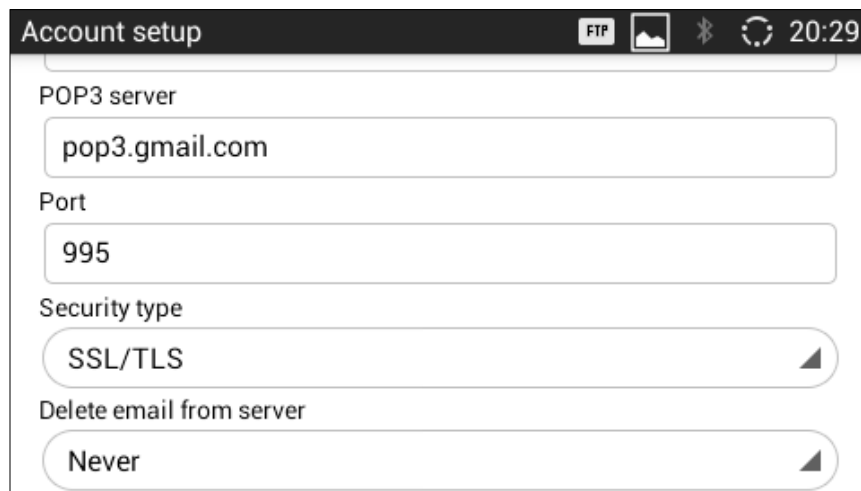
1. Enter the Email address and Password.
2. Tap on "Next" for quick setup, or tap on "Manual setup" to manually configure more options.
3. If "Manual setup" is selected in step 2, users will need to choose the account type "POP3" "IMAP" or "EXCHANGE" depending on the type of your Email account.





**Figure 103: Select Email Account Type**


- POP3 setup. When using POP3, the sent Emails are stored locally instead of the server side. Please check with your network administrators for the correct Email account settings for POP3.



**Figure 104: Email Account Type - POP3**

- IMAP setup. When using IMAP, the Emails stay on the server side and users can see them from other devices as well. Please check with your network administrators for the correct Email account settings for IMAP.





Account setup

IMAP server  
imap.gmail.com

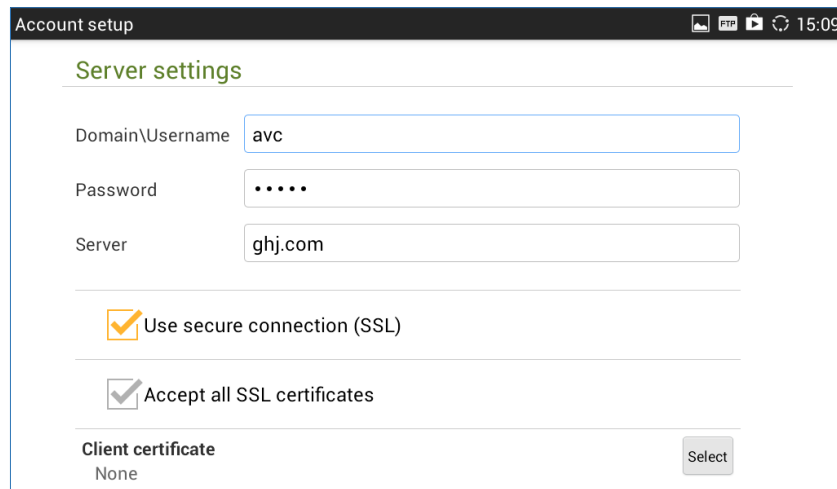
Port  
993

Security type  
SSL/TLS

IMAP path prefix  
Optional

**Figure 105: Email Account Type - IMAP**

- EXCHANGE setup. When using EXCHANGE, all Emails are stored in the central Exchange mail server and can be checked using capable mail client such as Microsoft Outlook. Please check with your network administrators for the correct Email account settings for EXCHANGE.



Account setup

**Server settings**

Domain\Username avc

Password .....

Server ghj.com

Use secure connection (SSL)

Accept all SSL certificates

Client certificate  
None Select

**Figure 106: Email Account Type - EXCHANGE**

4. If "Next" is selected in step 2, users will see the following default account settings. Tap on "Next" again.



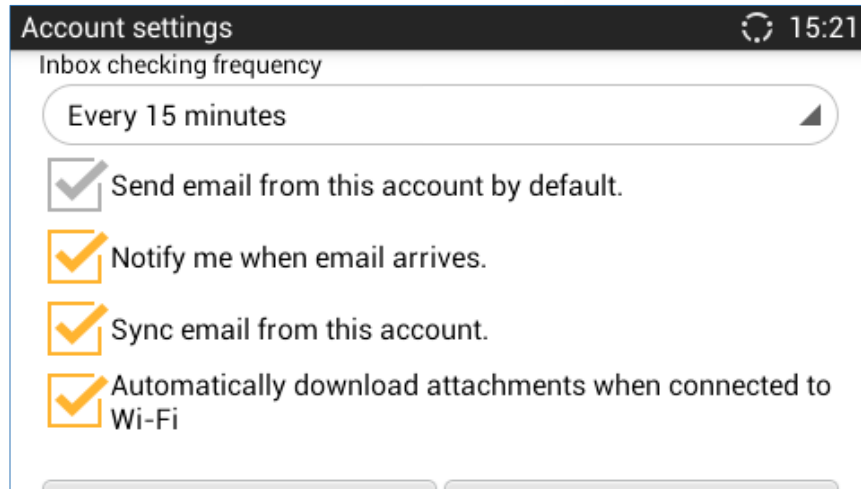


Figure 107: Email Account Settings


5. Set up "Your name" to be displayed on the outgoing messages and tap on "Next" again. Users should be able to start using the Email account now.

## Email Options


### Send Email

Tap on  to compose and send an Email.

### Search Email

Tap on  to search Email.

### Email Folders

Tap on  to open up folders.

### Multiple Email Accounts

Users could also add more than one Email account on the GXV3240. To do this, go to phone's **Settings**—>**Accounts**, tap on "Add account" and select "Email". A new Email account setup wizard will show up for users to add the Email account.

Once another Email account is successfully added, users could tap on the account Email address on the upper left to switch between the Email accounts.



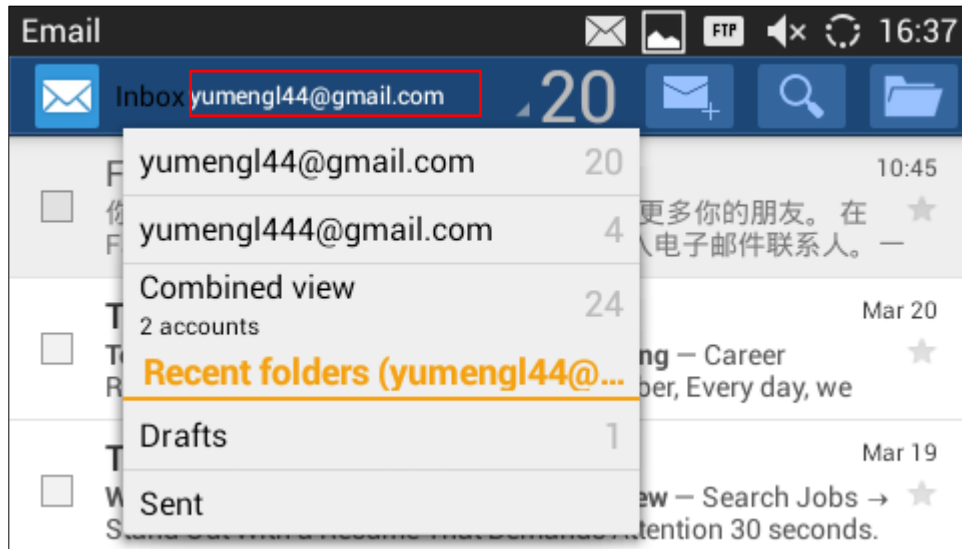



Figure 108: Multiple Email Accounts



## GS MARKET

The GXV3240 supports extensive amount of 3rd party Android applications. Users could install those applications from the built-in GS Market. If Google Play application is installed from GS market, users could log in and download all kinds of applications there as well.

Tap on  at the phone's menu or desktop to launch the GS Market. Users could browse, search, download and install the apps from there for tools, games and other applications.

### View APPS

Open GS market and there are four different categories "HOT", "APP", "GAME" and "TOOLS". In the displayed applications, tap on one of the application and users will be able to see the details such as descriptions, publish date, version, rate, comments and etc.

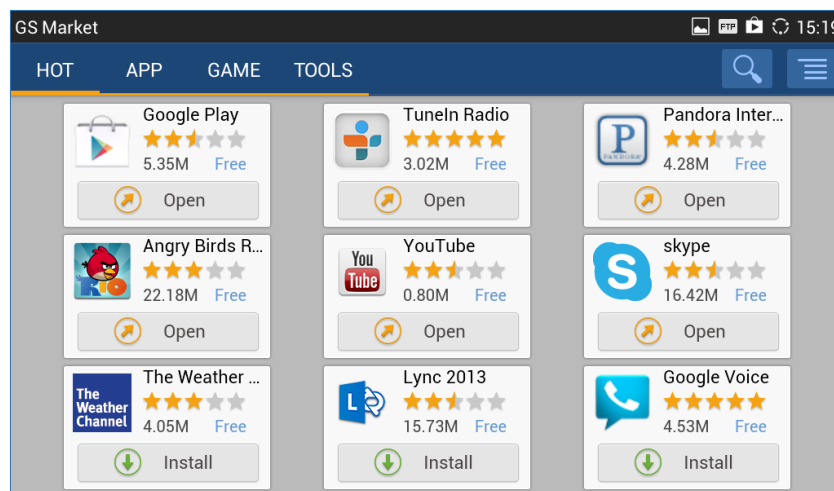




Figure 109: GXV3240 GS Market

### Search APPS

Open GS market and tap on  to input the key words for the app you are looking for.

### Download and Install APPS

1. Open GS market and find the app you would like to install.
2. Tap on "Install" softkey for the app. It will start downloading.
3. Once downloaded, the installation process will start automatically.

4. Tap on  to view the downloaded apps and installed apps from GS market.

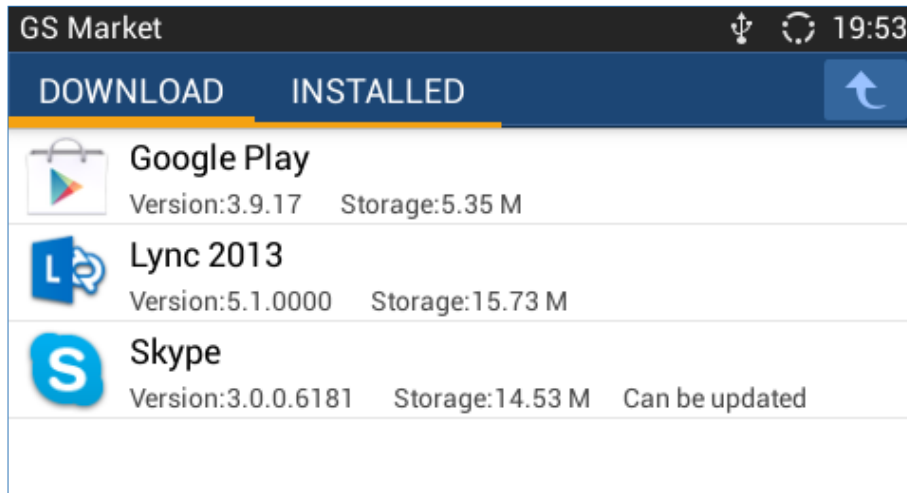



Figure 110: GXV3240 GS Market - Downloaded Applications

## Update APPS

The GXV3240 will automatically detect if there is a new version available for the installed apps to upgrade when the network connection is available and stable. Users can also view update status and manually update the apps in GS Market.

To update apps, open GS Market and tap on  to access the installed apps. Users will see the Update option for the app that has new version available.

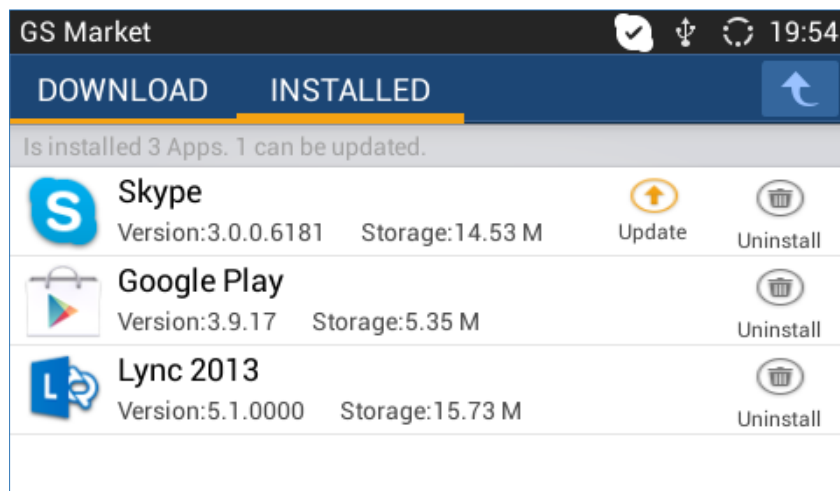



Figure 111: GXV3240 GS Market - Installed Applications

## Uninstall APPS

1. Open GS Market and tap on  to access the installed apps.
2. User will see "Uninstall" option for each app. Tap on "Uninstall" for the app you would like to uninstall.
3. A confirmation dialog will pop out. Tap on "OK" to start uninstallation.

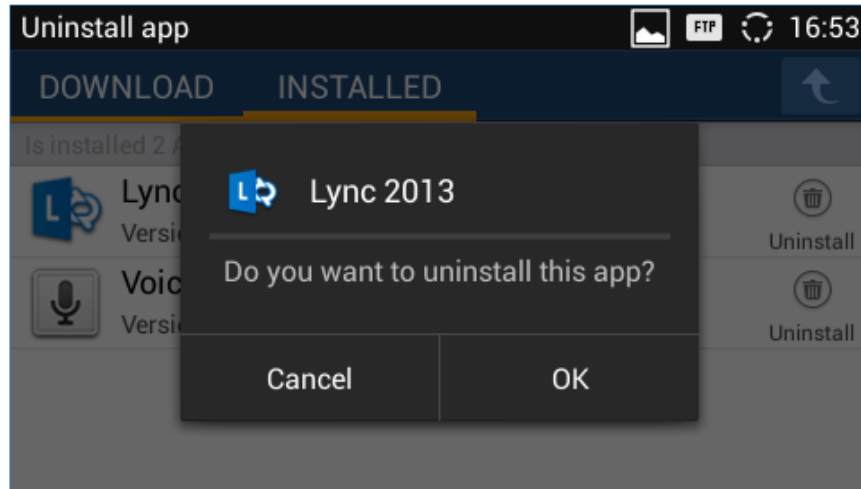



Figure 112: GXV3240 GS Market - Uninstall Applications



## TOOLS

### File Manager

File Manager is a tool that allows users to delete, move, copy/paste, send and rename files. It helps users to access and manage files in local storage as well as external storage devices (e.g, SD card/USB flash drive). Tap  on the phone's menu or desktop to launch File Manager application.

#### Copy And Paste Files

Follow the steps below to copy and paste a file on the GXV3240.

1. Open file manager and navigate to the directory of the file to be copied. Touch and press on the file for about 2 seconds until the checkbox shows up.

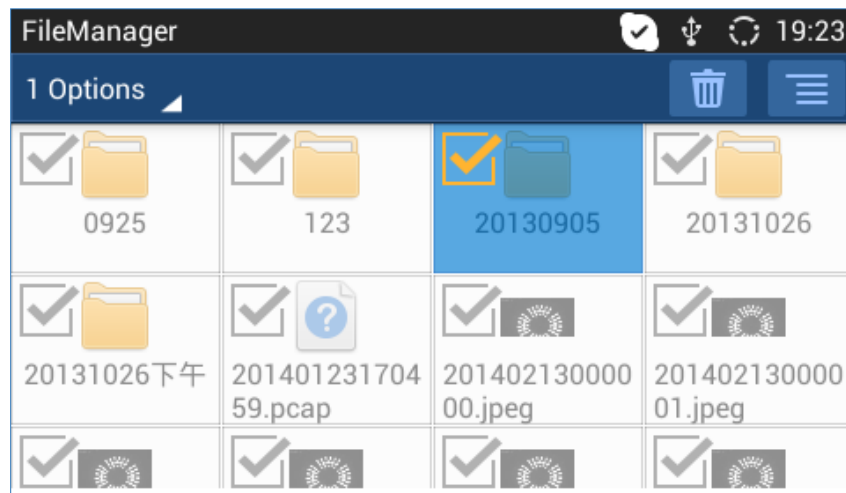





Figure 113: GXV3240 File Manager - Select File

2. Select the files or folders to be copied. Tap on  to select all files or unselect all files.
3. Tap on  and select "Copy". The file will be copied.
4. Tap on the root directory  to go back to the root directory. Navigate to the destination folder where you would like to paste the file to.



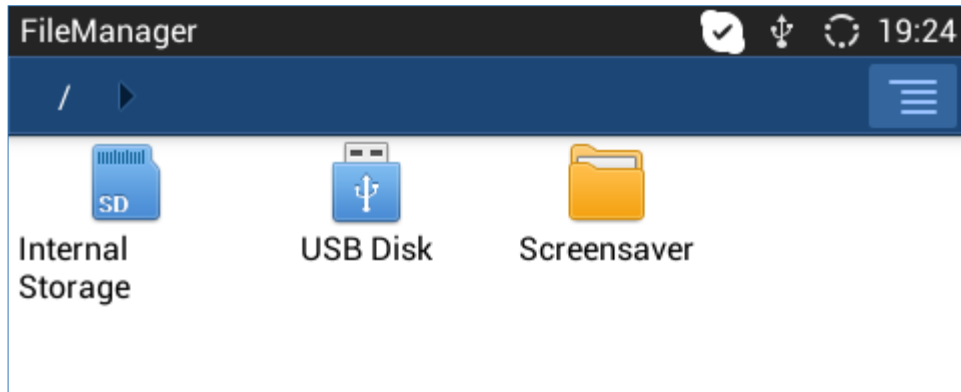


Figure 114: File Manager Root Directory

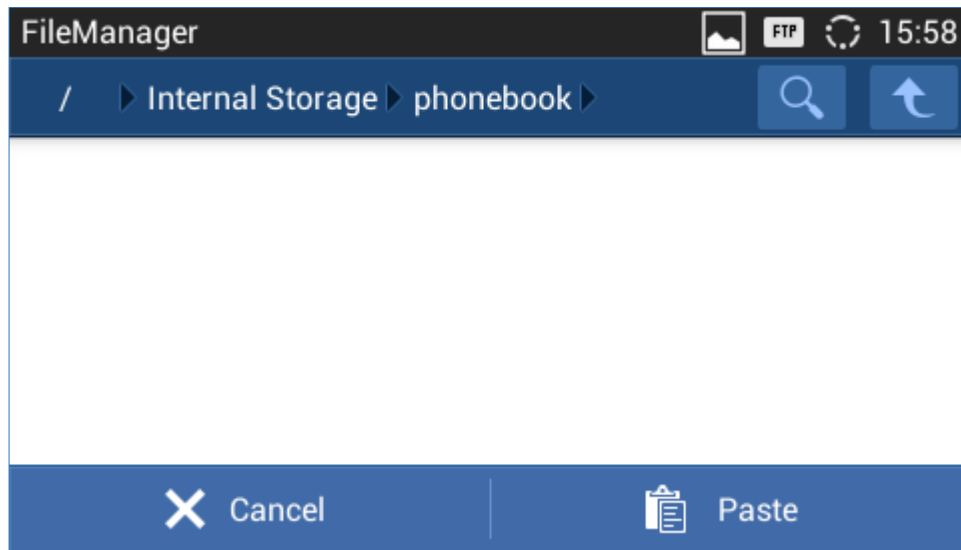


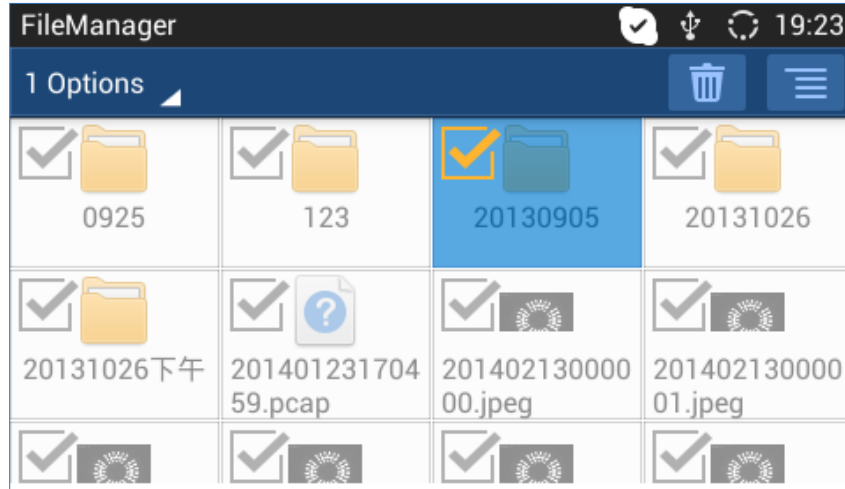
Figure 115: Paste File

### Move Files




The steps to move a file is similar to copy/paste a file. The difference is once the file is moved, the file will not be kept in the source folder. Follow the steps below to move a file on the GXV3240.

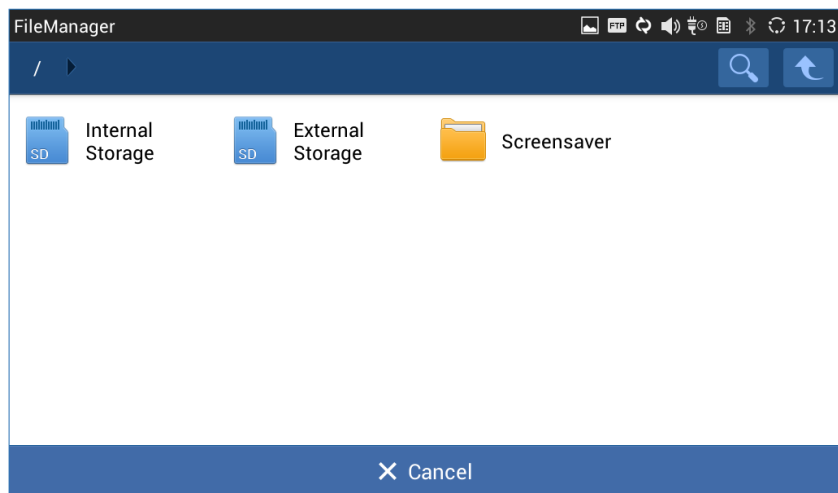
1. Open file manager and navigate to the directory of the file to be copied. Touch and press on the file for about 2 seconds until the checkbox shows up.





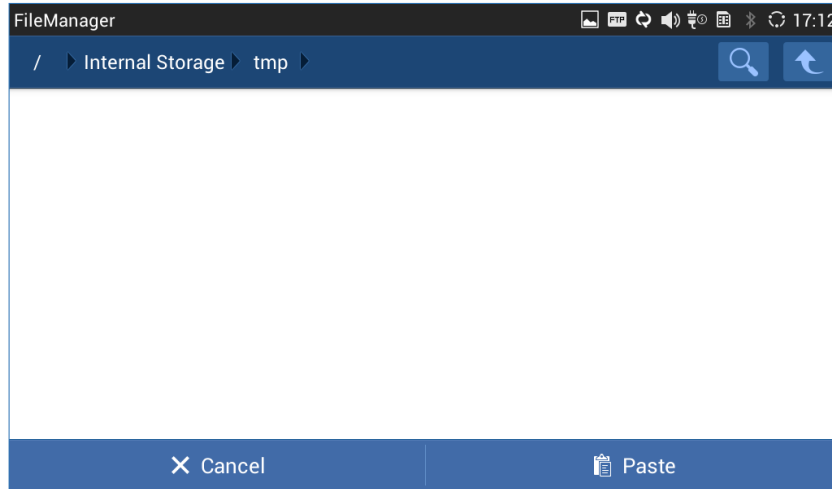
**Figure 116: GXV3240 File Manager - Select File**

2. Select the files or folders to be moved. Tap on  to select all files or unselect all files.
3. Tap on  and select "Move". The file will be copied.
4. Tap on the root directory  to go back to the root directory. Navigate to the destination folder where you would like to move the file to.



**Figure 117: File Manager Root Directory**





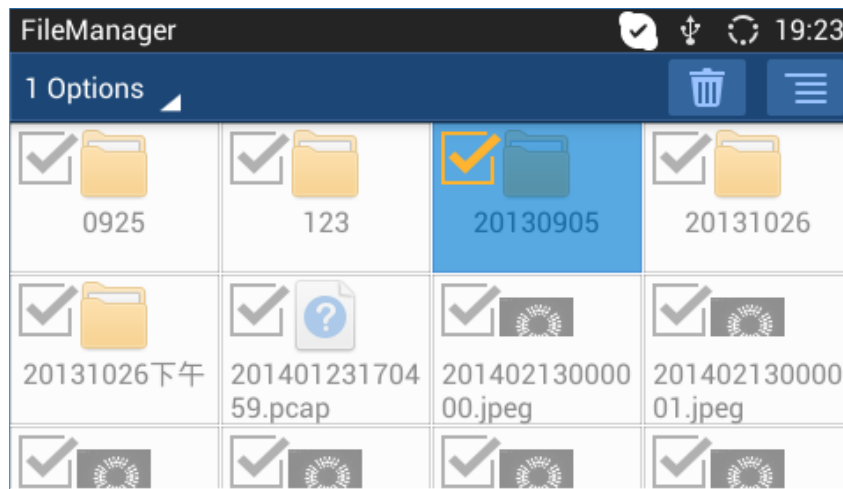
**Figure 118: Paste File**

### Send Files

The users can send a file via Bluetooth or other applications from file manager. Please make sure Bluetooth is turned on and connected to the Bluetooth devices, or the applications are set up properly already. Otherwise, users will be directed to set it up before the file can be sent out.


To send a file:

1. Open file manager and navigate to the directory of the file to be sent over. Touch and press on the file for about 2 seconds until the checkbox shows up.
2. Select the files or folders to be sent. Tap on **1 Options** to select all files or unselect all files.





**Figure 119: GXV3240 File Manager - Options**



3. Tap on  and select "Send". A new dialog window will pop up for users to send the file via Bluetooth or other applications.

### Delete Files

1. Open file manager and navigate to the directory of the file to be sent over. Touch and press on the file for about 2 seconds until the checkbox shows up.
2. Select the files or folders to be sent. Tap on  to select all files or unselect all files.
3. Tap on . A confirmation dialog will pop up.
4. Tap on OK to delete the file(s).

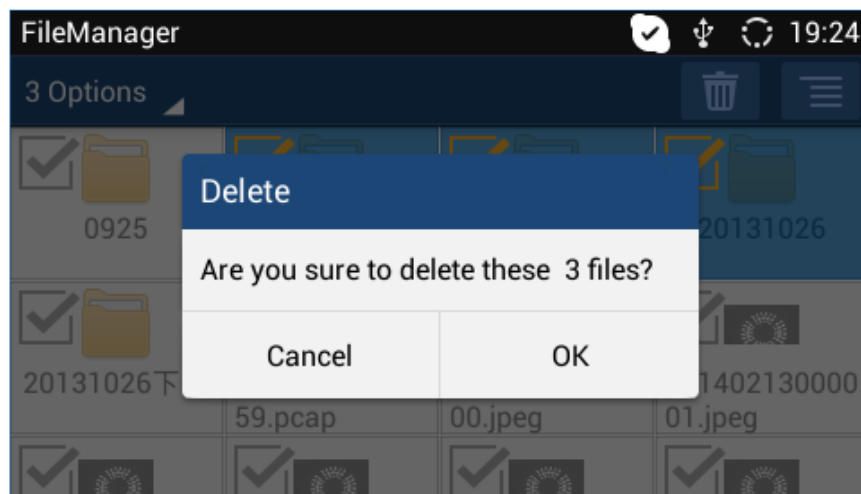



Figure 120: Delete File(s) via File Manager

### Rename A File

1. Open file manager and navigate to the directory of the file to be sent over. Touch and press on the file for about 2 seconds until the checkbox shows up.
2. Tap on  and select "Rename". A new dialog window will pop up for users to enter the new name.
3. Tap on OK.



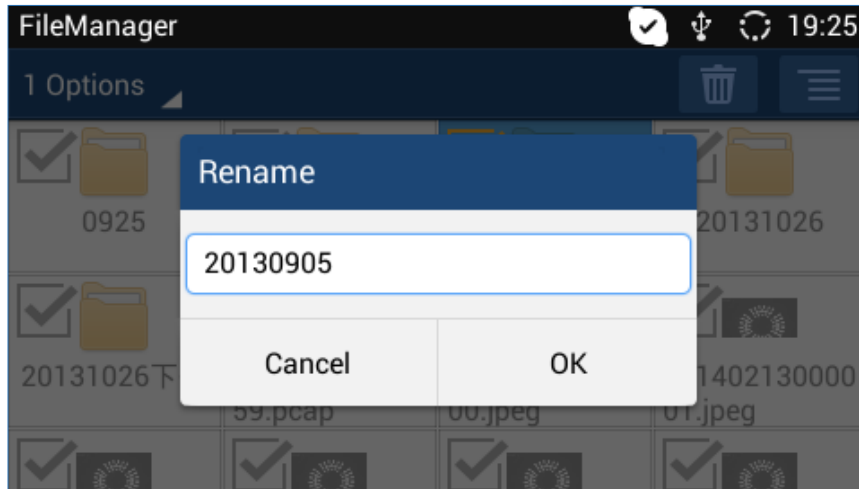


Figure 121: Rename File

---


 **Note:**

Under the File Manager root directory, screensaver is a system folder that users could not create or delete files/folders there.

---



## FTP SERVER

The GXV3240 supports file transfer via FTP server. Once installed, users could access the GXV3240 file system from PC. Tap on  in the phone's menu or desktop to open FTP Server application.

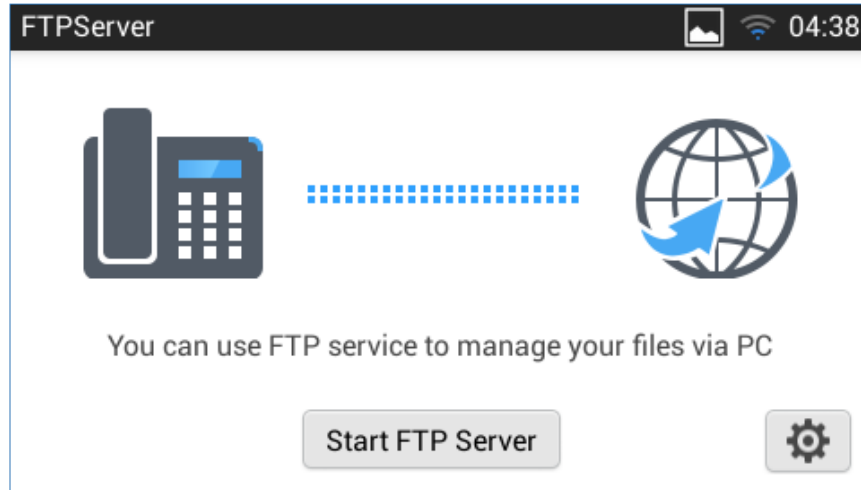


Figure 122: FTP Server - Start

Tap on "Start FTP Server" to turn the server on. The FTP server address URL will be provided on the screen.

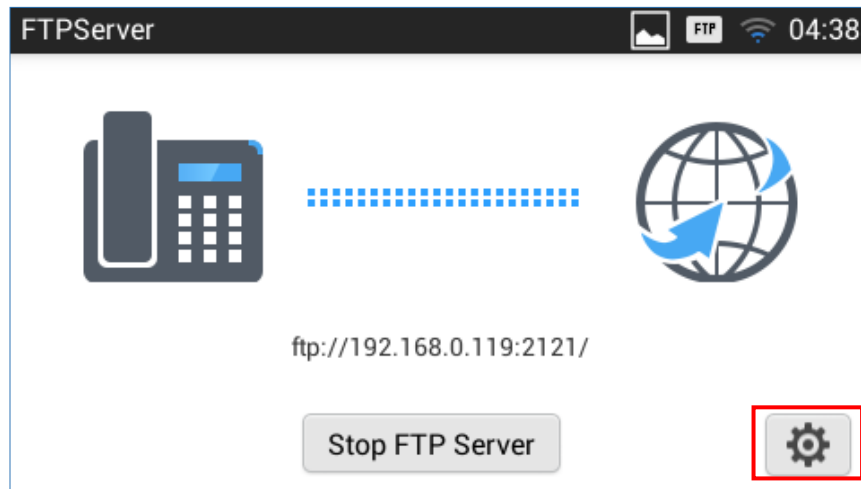


Figure 123: FTP Server - Stop

For security purpose, users could also tap on  in the above figure to set up username, password,

port number and directory for remote access. By default, when the users access the ftp server from a PC, a prompt will show asking for user name and password. The default user name and password are "admin".

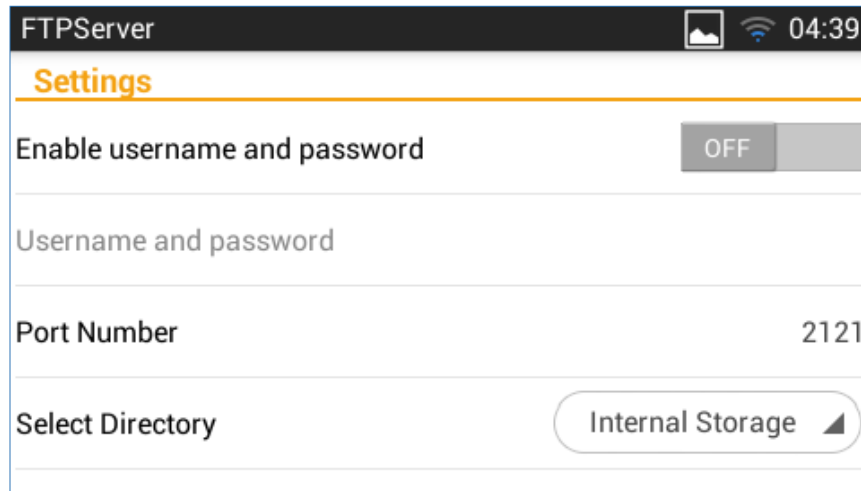


Figure 124: FTP Server – Settings



## RECORDER

GXV3240 Recorder application allows users to record audio and access recording files from call recording. There is no time limit on the recorder as long as there is enough space to save the recording file. Tap on



on the phone's menu or desktop to launch the Recorder application.

### Normal Recorder

Normal recorder shows the recording files recorded using the Recorder application.

Recorder		19:33
NORMAL	CALL	
20140227193307461		Duration 00:03
19:33:12		
20140227193244103		Duration 00:07
19:32:51		
20140227193236909		Duration 00:02
19:32:39		

Figure 125: Normal Recorder

To use the recorder app to record audio, tap on  open the recorder.

1. Tap on  to start recording.



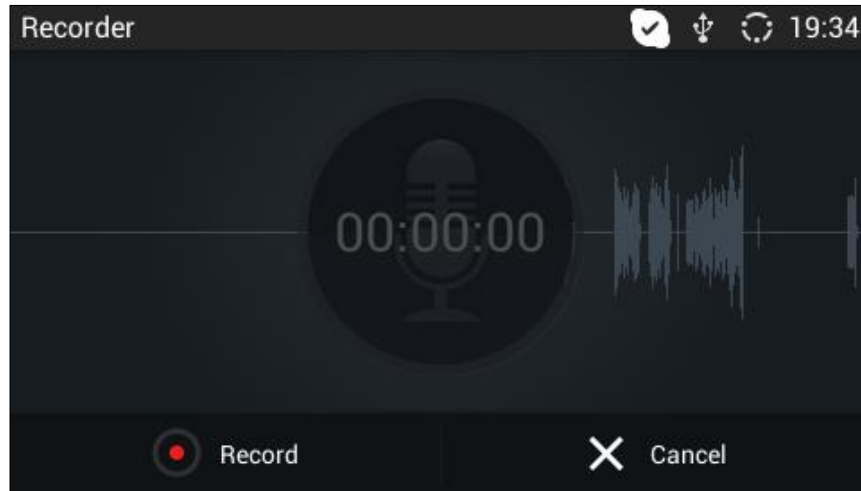


Figure 126: Normal Recorder - Start Recording

2. Tap on "Save" to end recording.

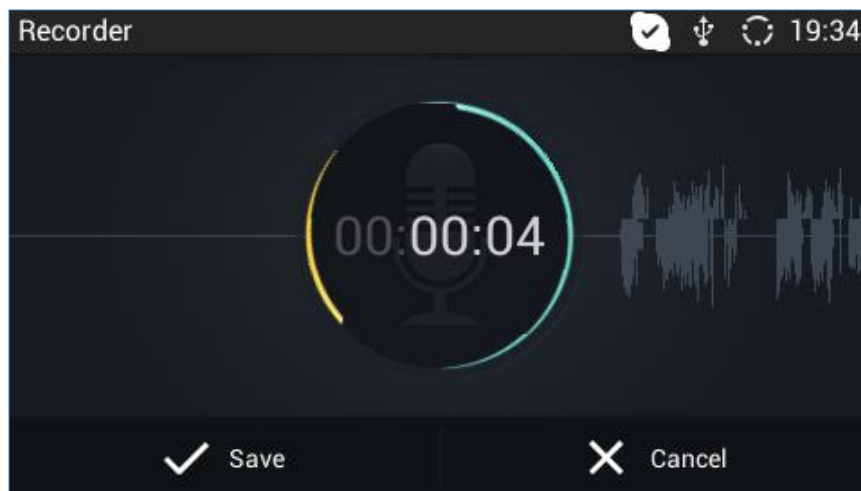


Figure 127: Normal Recorder - End Recording

3. The file will be saved and accessible under Recorder application "Normal" category. Tap on the recording file to play the recording.

## Call Recorder

During an active call, users have the option to record the conversation. The recorded conversation can be retrieved here.

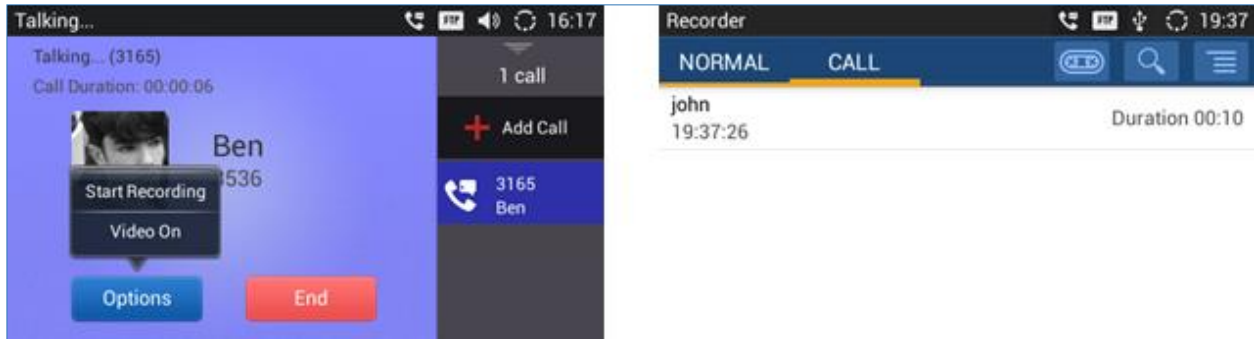



Figure 128: Call Recorder

## Downloads

The Downloads application can be opened by tapping on  on the phone's menu or desktop. The files (such as PDF documents, pictures) downloaded from the browser will be stored in the internal storage and can be access from Downloads application.

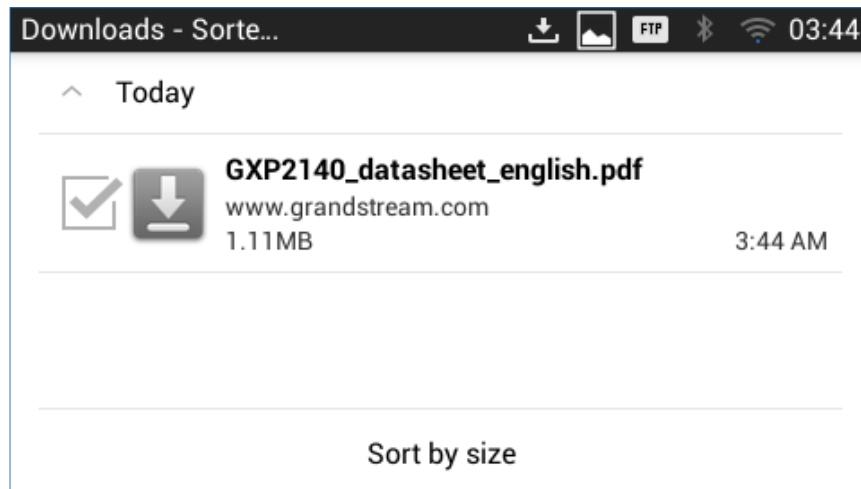


Figure 129: Downloads

- Tap on the file to open it.
- Tap on the checkbox to select the file. Then users could delete or share the file.
- Tap on "Sort by size" or "Sort by date" to sort the downloaded files.

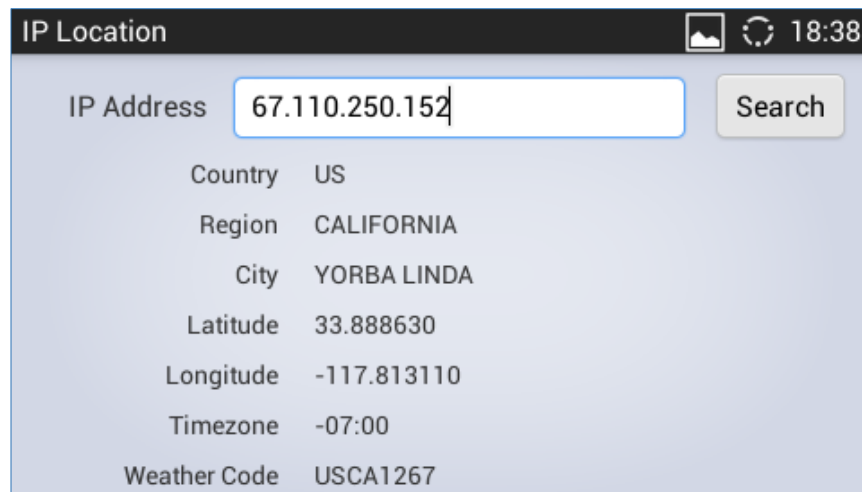
## IP Location

The IP Location application provides users with a tool to resolve the public IP address to the location. Tap



on to  on the phone's menu or desktop to launch the IP Location application.


In the IP Location application, users could simply enter the public IP address and then tap on **Search** to view the result. Based on the IP address provided, the following information will be given: **Country, Region, City, Latitude, Longitude, Time Zone** and **Weather Code**. This information is useful when configuring the phone to provide personalized settings based on user's location.



**Figure 130: GXV3240 Location**

For example, in the above figure, the public IP address 8.8.8.8 is mapped to Mountain View in California, USA. The time zone is UTC-07:00 and the weather code is USA0746.

## Diagnosis

The GXV3240 provides a built-in diagnosis application for users to troubleshoot hardware issues related to LCD, keypad, and touch screen, LED as well as extension board connection. Tap  on the phone's menu or desktop to launch Diagnosis application. The following figure shows the diagnosis menu. After selecting the option, users could follow the diagnosis instruction to troubleshoot the device.




LCD Diagnosis
LCD Off
Keypad Diagnosis
Touch Screen Diagnosis
LED Diagnosis
BI E Expansion Board Diagnosis

**Figure 131: GXV3240 Diagnosis**



## CAMERA

The GXV3240 has built-in Camera to support taking pictures and recording videos. Users can also use the camera during SIP video calls as well as video calls via 3rd party applications such as Microsoft Lync. To

access Camera to take pictures and videos, tap on Camera icon  on the desktop or phone's menu.

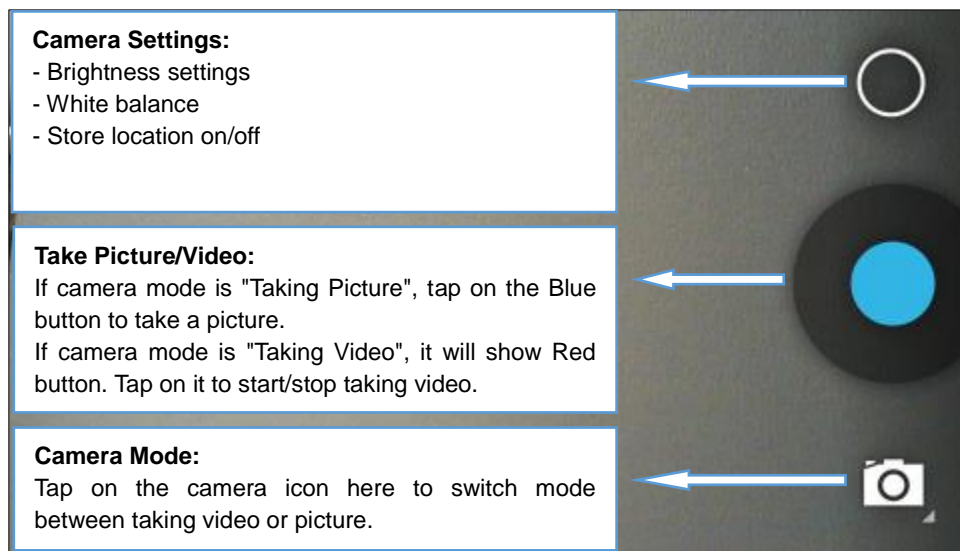




Figure 132: GXV3240 Camera

### Take Picture


1. Select the camera mode as  to take picture.
2. Tap on the Blue button to take a picture.
3. The captured picture can be accessed under **FileManager->Internal Storage->DCIM->Camera**.

### Record Video

1. Select the camera mode as  to record video.
2. Tap on the Red button to start/stop recording.
3. The recorded video can be accessed under **FileManager->Internal Storage->DCIM->Camera**.



## Camera Settings

Tap on icon  to bring up camera settings.

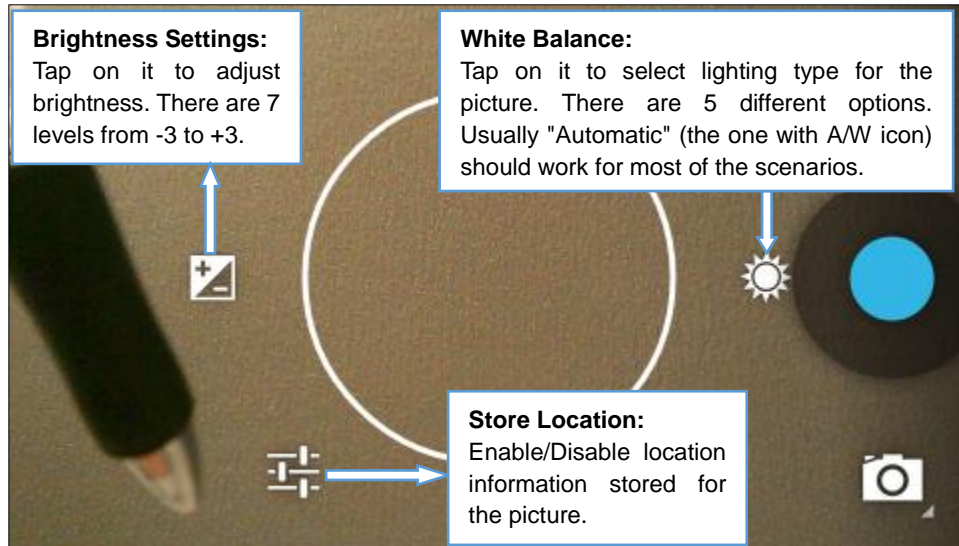



Figure 133: GXV3240 Camera Settings


## Angle Adjustment

On the back of the GXV3240 camera, users could scroll the wheel up/down to adjust the camera angle. If users scroll the camera all the way up until the icon  shows up on the status bar of the screen, the camera is turned off.

## MULTIMEDIA

### Gallery

The GXV3240 has built-in Gallery application for users to take pictures/videos, view pictures and play videos from GXV3240 internal storage or USB/SD card storage. Users could also perform basic editing tasks on pictures and set them as wallpaper or picture for contacts. The pictures can be easily shared with friends in Gallery app by sending via Bluetooth and Email.

Tap  on the phone's menu or desktop to launch the gallery application on the GXV3240.

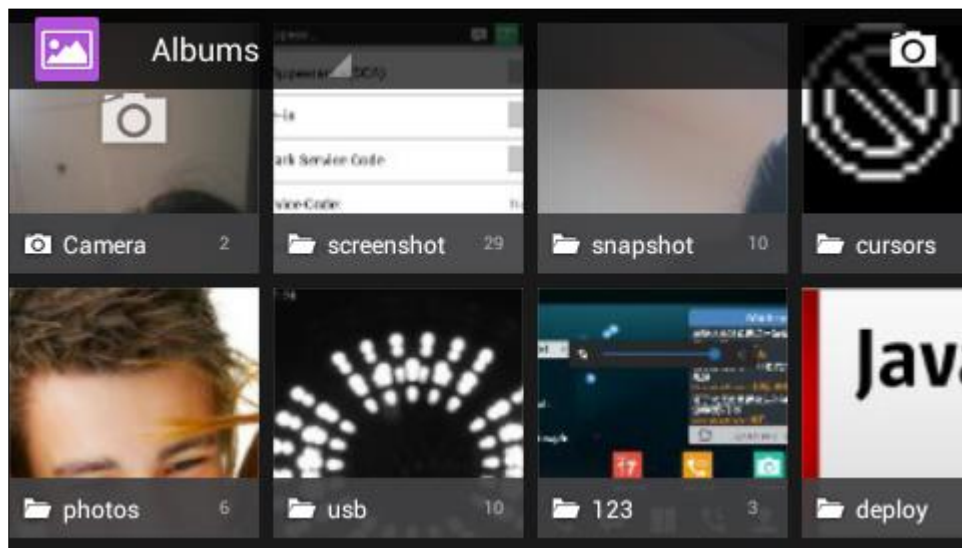



Figure 134: GXV3240 Gallery

- Gallery albums**  
 The image related folders in the GXV3240 will be present in Gallery as thumbnails. Users can tap on the thumbnail to access the folder.
- View pictures**  
 After accessing the album, slide left/right to view all the pictures. Users could select "Grid" or "Filmstrip" view mode to display the pictures. Tap on a specific picture to view the picture in full screen.
- Edit picture**  
 When the picture is displayed in full screen, tap on the screen again. On the lower left corner, users will see icon . Tap on it and users can crop/rotate/add effect to the picture.



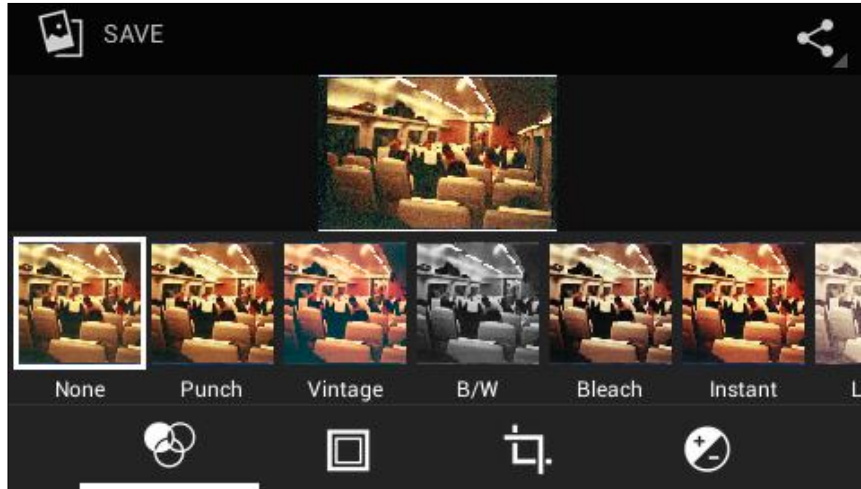



Figure 135: GXV3240 Gallery - Edit Picture

- **Picture Options**

When the picture is displayed in full screen, press the Menu button . A list of options will be available for users to select, including "Delete", "Edit", "Rotate", "Crop" or "Set Picture as", etc.

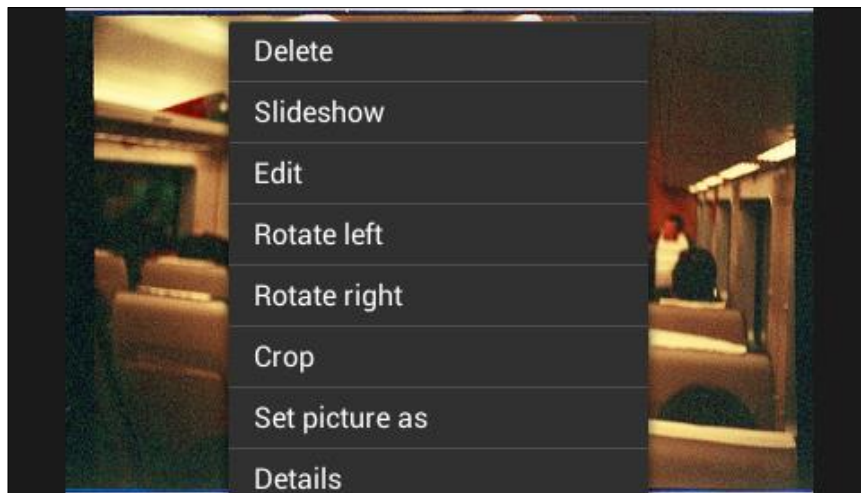





Figure 136: GXV3240 Gallery - Picture Options



- **Take picture/video**

Tap on  on the upper right of the Gallery to start taking pictures or videos using the GXV3240 built-in camera. In the camera mode, users could tap on  to take video and tap on  to take picture on the bottom right.


- **Select multiple pictures**

Touch and press on one of the pictures for about 2 seconds until the picture is highlighted. Tap on




other pictures to select multiple pictures. On the upper right of the Gallery app, users can tap on  to share the pictures, or tap on  to delete the selected pictures


- **Share pictures**

Tap on  on the upper right of the picture to send the picture via Bluetooth or 3rd party applications.

## Music

The GXV3240 has built-in music player to support audio files in AAC, MP3, AMR, WAVE, MIDI and Vorbis format. Tap on icon  on the phone's menu or desktop to launch Music application.

### Play Music

1. Download music to have the music files ready in USB flash drive/SD card plugged into the GXV3240.
2. Open Music application.
3. Tap on  and select "Refresh". The music files will be displayed in the list.

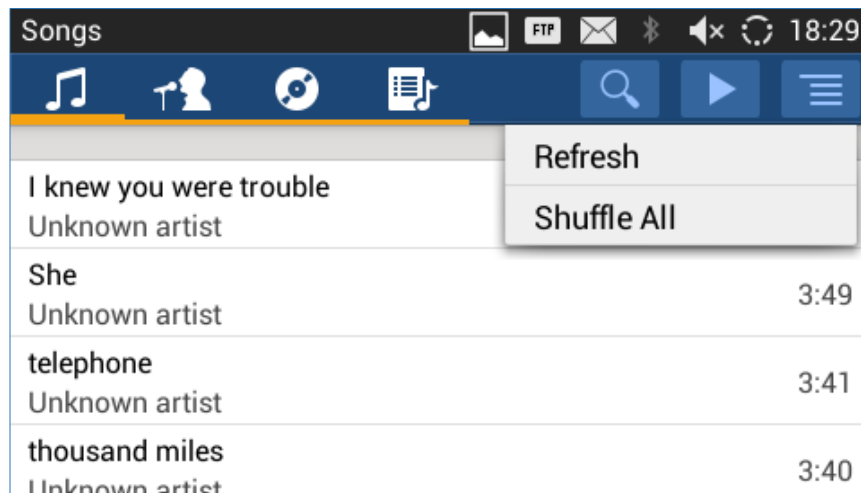



Figure 137: GXV3240 Music - Refresh Music List

4. Select a song and tap on  to play the song.

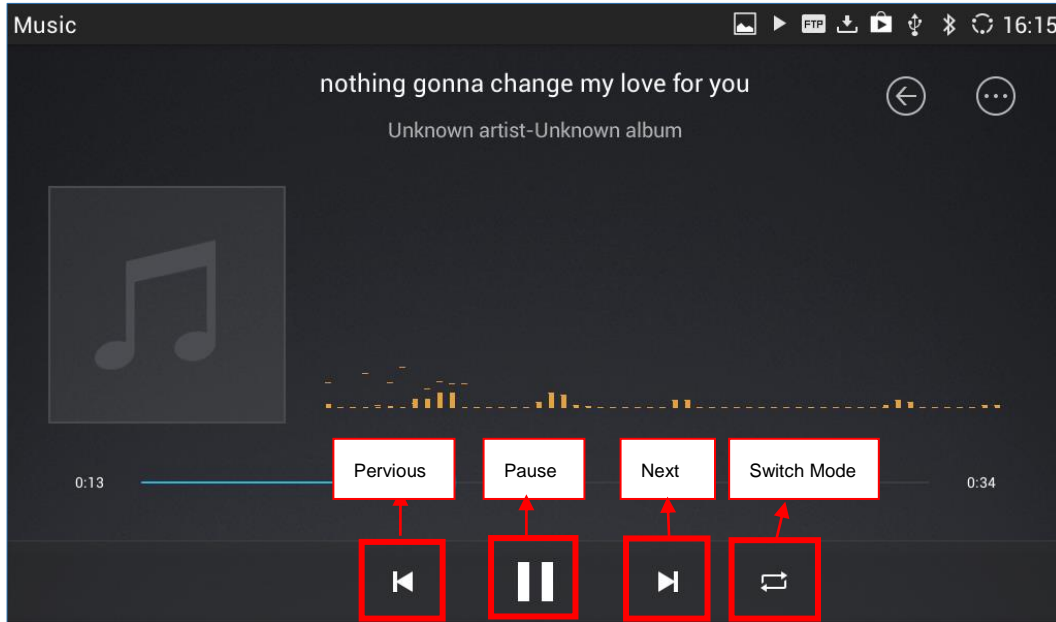



Figure 138: GXV3240 Music - Play a Song

### Edit Music

1. In the music list, touch and press on one of the music file until the checkbox displays.
2. Tap on  and users will be able to "Play" the music, "Add To PlayList" and "Save As Ringtone".

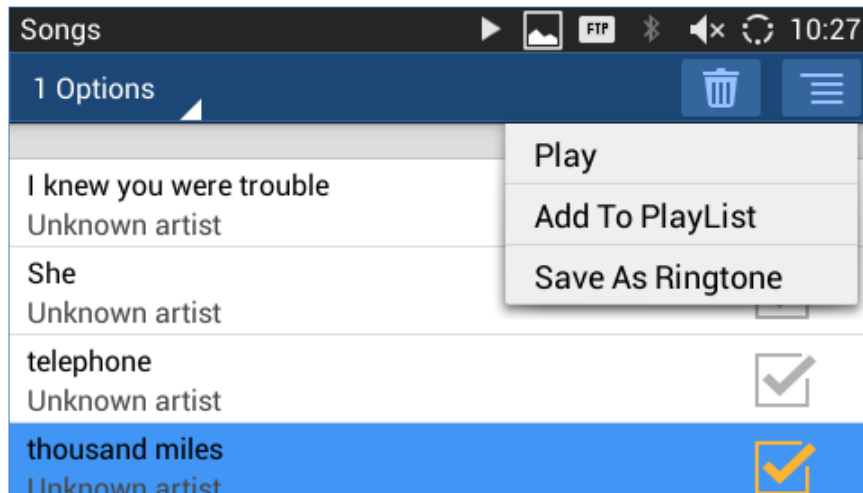


Figure 139: GXV3240 Music - Options



## Sort Music

On the top menu of the Music application, users can sort music by "Song", "Artist", "Album" and "Playlist".

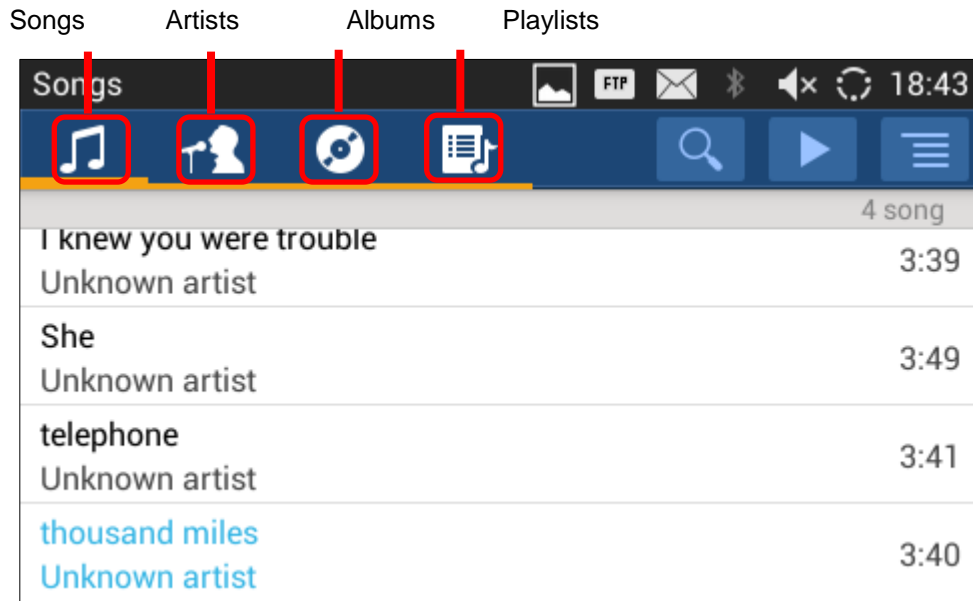






Figure 140: GXV3240 Music - Sort Songs

## Search Music

1. Tap on  to access the lists of songs.
2. Tap on  and enter the name of the song to search.

## Create Playlist

1. Tap on  to access Playlists.
2. Tap on  to create a new playlist.



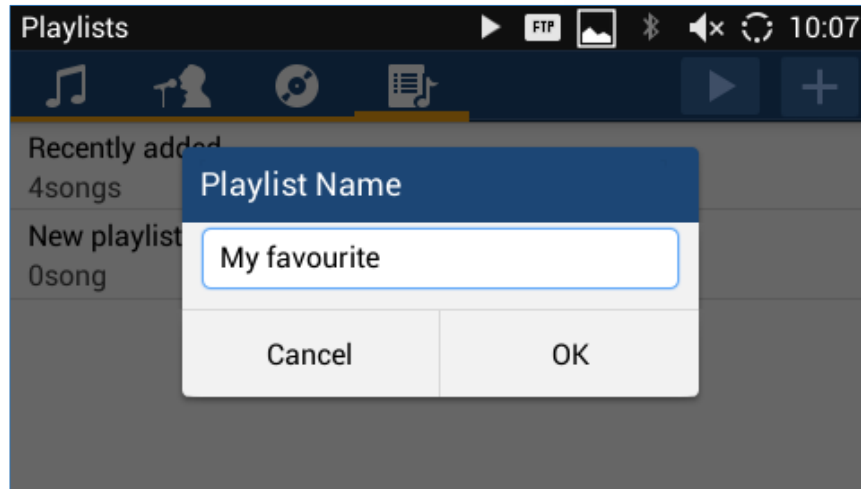





Figure 141: GXV3240 Music - Create Playlist


### Edit Playlist

1. Tap on  to access Playlists.
2. Touch and press one of the playlist for about 3 seconds to select it.
3. Press  to bring up options to play the playlist or rename the playlist.
4. Tap on  to delete the selected playlist.

Once the playlist is created, users can touch and press it for about 3 seconds.



## BROWSER

GXV3240 browser could be used in a similar way as a PC-based web browser, i.e., open web pages, bookmarks, view history, search and etc. Tap  on the phone's menu or desktop to launch the Browser application.

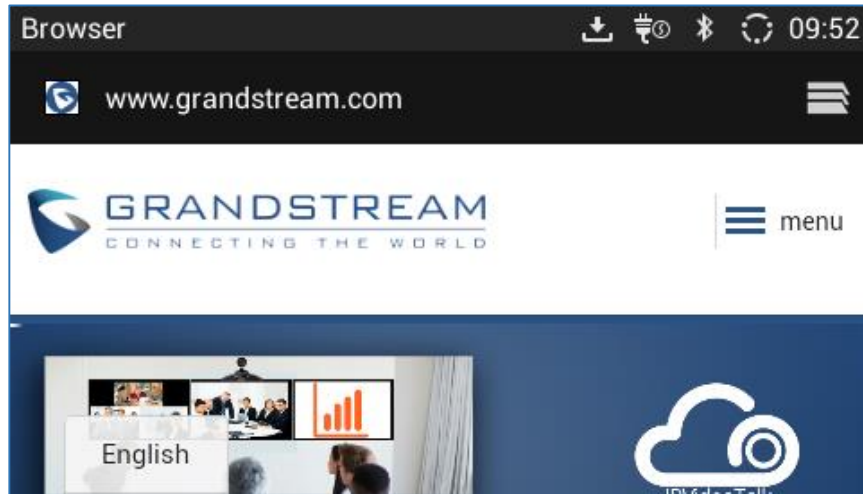



Figure 142: GXV3240 Web Browser

- Touch the screen and scroll up/down/left/right to view the web page.
- Double tap on the screen to zoom in/zoom out. Or use two fingers on the screen to pinch in or spreading out the page.
- Press the MENU button  to access more options including bookmarks, share the page and etc.

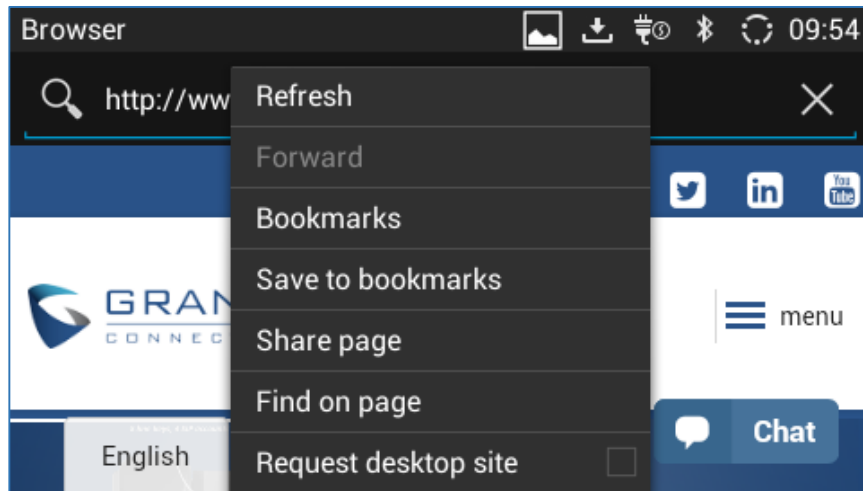


Figure 143: GXV3240 Browser Menu Options



- To open a new window, tap on  icon on the right side of the tab.

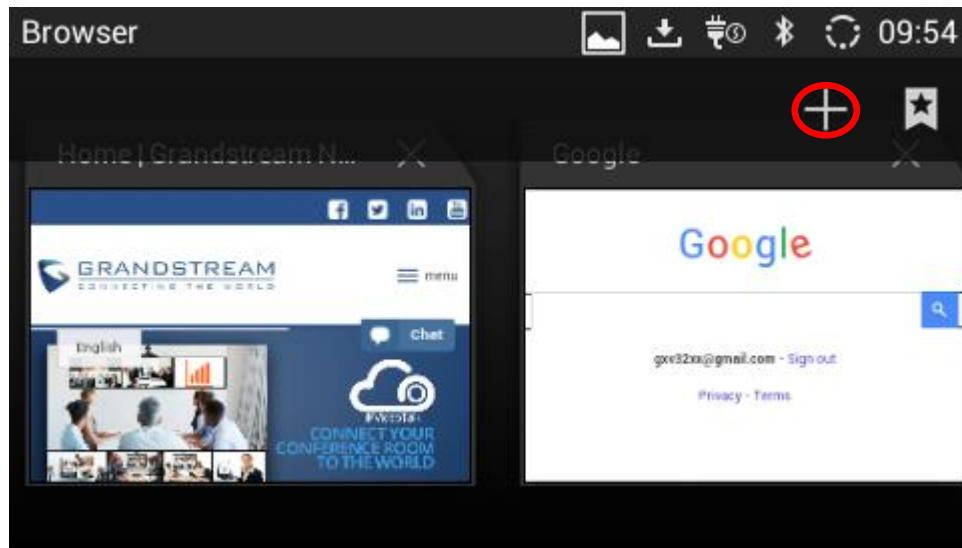



Figure 144: Open New Window in Browser

- To open **Bookmarks**, **History** and **Saved Pages**, tap the icon  on the upper right of the Browser and choose which pages you want to display from the drop menu.

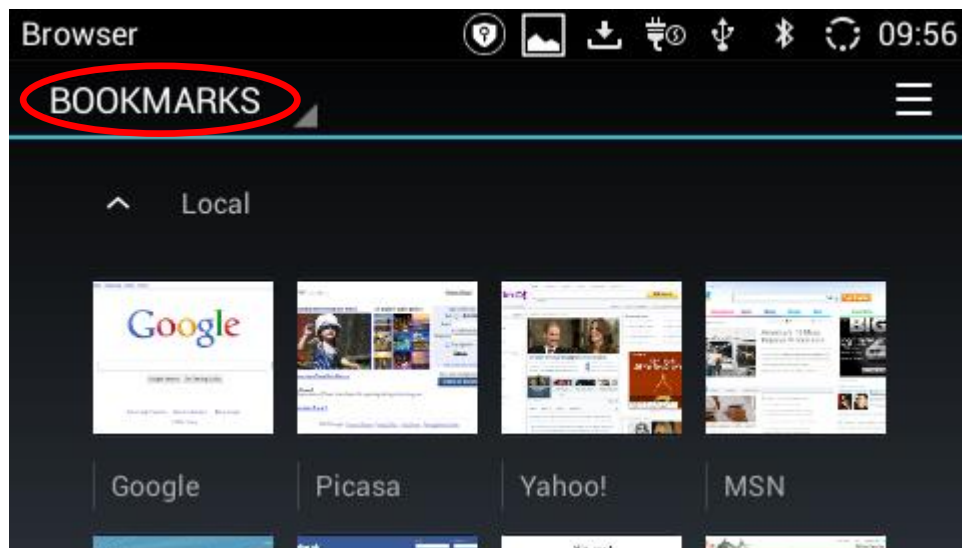



Figure 145: GXV3240 Web Browser-Bookmarks



## RSS NEWS

### Add RSS Widget

1. On the GXV3240 idle screen, press Settings button  and select "Edit Widgets".
2. A list of widgets will show on the bottom of the screen. Swipe left/right to find the "RSS News" widget.
3. Touch and drag it to the idle screen. Please make sure there is enough space on the idle screen to place the widget.

### Use RSS Widget


On the RSS widget, users can tap on icon  to refresh the page, scroll up/down to view the abstract of the news, and tap on the news to access the detailed content.



Figure 146: GXV3240 RSS News


### RSS Widget Settings

On the RSS News widget, tap on  to access RSS News settings.

- **Update Interval:** Configure the interval to refresh the news. The valid range is from 10 minutes to 24 hours.
- **Page-turning Intervals:** Configure the page-turning speed on the widget when it displays different pages of news.
- **Subscribe:** Select the categories of the news you would like to display on the RSS News.



- **RSS Feed:** Tap on the URL field on the bottom of the screen and enter the link of a new RSS feed.

Then tap on icon  to add it to the category of the RSS feed.

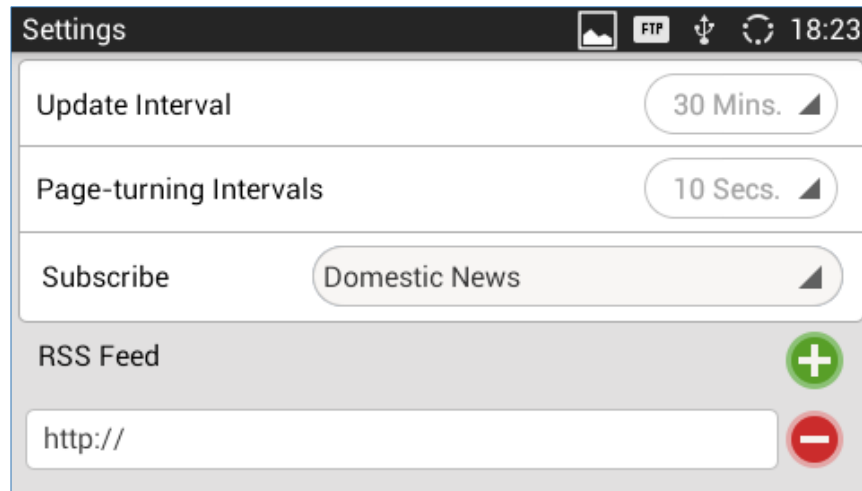



Figure 147: GXV3240 RSS News Settings

## Weather

GXV3240 has a built-in Weather widget that provides weather information includes humidity, wind direction, wind speed (mph) and temperature in unit as configured by the users.

### Add Weather Widget

1. On the GXV3240 idle screen, press Settings button  and select "Edit Widgets".
2. A list of widgets will show on the bottom of the screen. Swipe left/right to find the "Weather" widget.
3. Touch and drag it to the idle screen. Please make sure there is enough space on the idle screen to place the widget.

### Use Weather Widget


On the Weather widget, tap on  to refresh the weather information. Users can also tap on the widget to access the settings.



Figure 148: GXV3240 Weather

### Weather Settings

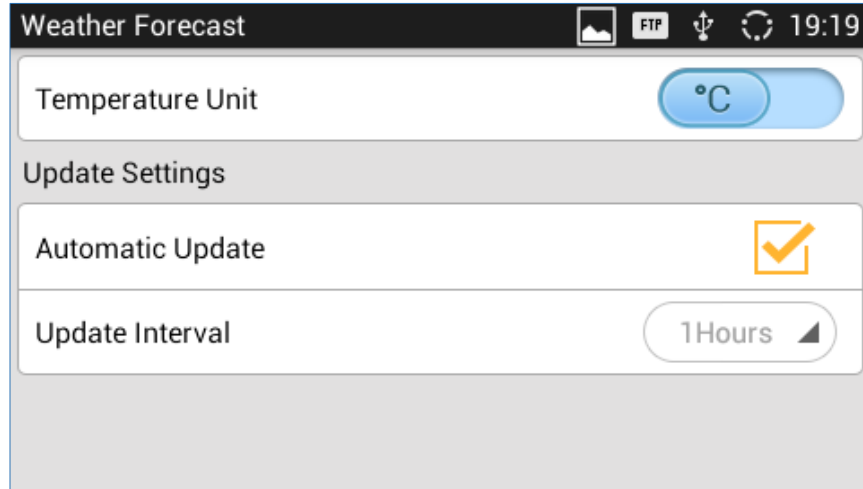
Tap on the weather widget to access settings. Users will see four softkeys on the bottom of the screen.



Figure 149: GXV3240 Weather Settings

- **"Update"**: Tap to refresh the weather information.
- **"Share"**: Tap to share the weather information with other users.
- **"Add City"**: Tap to add city for the location you would like to check the weather.
- **"Settings"**: Tap on configure temperature unit and update interval time.





**Figure 150: GXV3240 Weather Update Settings**



## **BS-IM&P**

GXV3240 supports BroadWorks Instant Message and Presence (IM&P) feature. This service is a multi-tenant Instant Message & Presence service based on the Extensible Messaging and Presence Protocol (XMPP) and works with any XMPP compatible client. Please refer to the following link for more details about how to use BroadWorks IM&P on the GXV3240:

[http://www.grandstream.com/sites/default/files/Resources/GXV\\_IM%26P\\_Guide.pdf](http://www.grandstream.com/sites/default/files/Resources/GXV_IM%26P_Guide.pdf)



## ACTIONURL

GXV3240 supports ActionURL module, and it is used to set the URL for various kinds of phone events on phone web GUI, and when the corresponding event occurs on the phone, phone will send the configured URL to SIP server. To use ActionURL module, users need to know the supported events in this module, and also added the dynamic variables of the supported events on phone web GUI. The dynamic variables of the supported event will be replaced by actual values of the phone, in order to notify the event to SIP server. Please refer to GXV3240 Administration Guide and ActionURL User Guide for the configuration details.

[http://www.grandstream.com/sites/default/files/Resources/ActionURL\\_Guide.pdf](http://www.grandstream.com/sites/default/files/Resources/ActionURL_Guide.pdf)



## PNP

The GXV3240 has built in PNP (Plug and Play) application to mass provision for other Grandstream phone clients. The PNP feature is for other phones to be able to find the configuration path and download their configuration settings with little or no configurations from GXV3240. It gives the GXV3240 phone accessibility to many phones' settings and features that can be configured, making it unnecessary to configure these settings on other phones themselves.

### Set Up PNP Application

It needs to configure the Account 1's setting properly before implementing the PNP feature on GXV3240.

1. Check the Account Active box for Account 1.
2. In Account 1's SIP setting page, disable the Validate Incoming SIP Messages feature.
3. In Account 1's SIP setting page, set the SIP transport protocol to UDP.
4. In the Account 1's SIP setting page, do not use 5060 as the Local SIP Port. This setting will be overridden to 0 automatically when the PNP feature is enabled. The port number with 0 refers the port number will be random.

### Enable PNP Feature



After the settings above, end users can enable the PNP feature for GXV3240. It can be enabled from the web page or from the LCD screen.

#### Enable from Web Page

1. Log in the GXV3240 web page, browse to Maintenance→ Upgrade.
2. Check the Enable PNP Feature box.
3. In the PNP URL box, type the URL path for the saved configuration file with protocol identifier. For example, <http://192.168.1.200/config>. The protocol identifier can be selected from tftp, http, and https.
4. GXV3240 supports the built-in httpd server feature. End users can save the config file in the GXV3240 device and it can be set as a file server transport the files to other phone client. If end user needs this feature, the config file should be saved in the directory */Internal Storage/npn*. And the PNP URL should be point to the npn directory. For instance, if a user wants to set his GXV3240 as a HTTP file server, whose IP address is 192.168.1.100, and the config file is saved in the directory */Local Storage/npn*, it needs to enter <http://192.168.1.100/npn>. If it needs to transport the file via HTTPS, it needs to set the Access Method to HTTPS under the page of Maintenance→Web/SSH Access.
5. Then save the setting and reboot the unit. If the Account 1's Local SIP port does not be set to 0, the phone system will pop up a prompt window and it writes "The local SIP port is 5060 in your account, save the operation will change the port to the random one, sure to change?" Click OK to change to port from 5060 to 0 by force.



## Enable from LCD

1. On the LCD screen, tap the icon  to enter the PNP application.
2. Tap the Setting icon  at the upper right corner of the screen to enter the PNP-Settings page.
3. In the Settings page, switch the PNP feature on and switch the 3CX Auto Provision off. Type the URL to the Configuration file path in the correct format. And if the GXV3240 needs to be set as a file server, it needs to load the configuration file to the directory /Local Storage/pnp via the Import local configuration file.
4. Save the setting and reboot the device.

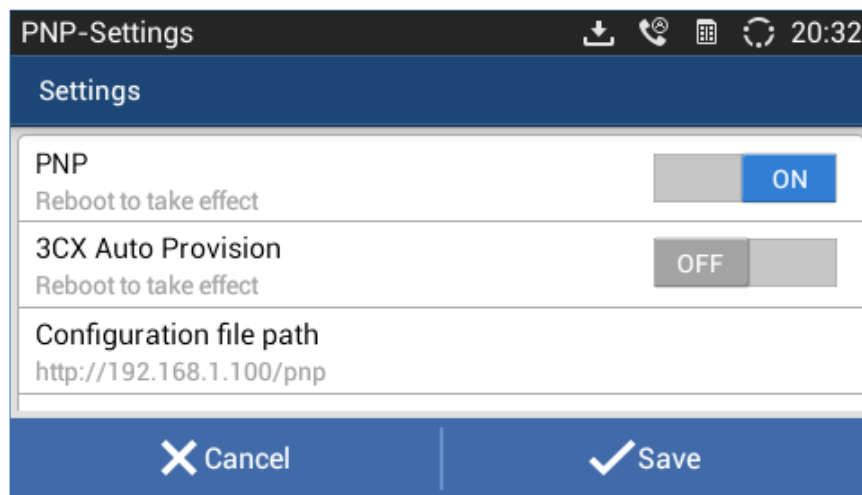


Figure 151: GXV3240 PNP Settings

**Note:** When PNP feature is enabled, a notification icon will be shown on LCD top status bar.

## Use PNP Feature

After setting up the PNP feature on GXV3240, the other client phone units will multicast the SIP SUBSCRIBE message while booting up if their 3CX Auto Provision feature has been enabled. Then the client phone units configuration server path and transportation protocol will be provisioned by the SIP NOTIFY message from the GXV3240 device. After then the client phone units will download the config file from the provisioned URI.



## CONNECT TO NETWORK AND DEVICES

The GXV3240 supports a variety of network connections (Ethernet, Wi-Fi) and device connections, including EHS headset (Plantronics), USB, SD card and Bluetooth device. Users can connect the GXV3240 to transfer files from/to the GXV3240 using a USB connection, SD card or Bluetooth.

### Ethernet

Ethernet connection is turned on as DHCP by default. If you would like to use Ethernet connection for network access, please make sure the Ethernet cable is plugged in to the LAN port on the back of the GXV3240.

To configure Ethernet settings on GXV3240 LCD:

1. Go to GXV3240's Settings application->**Wireless & Network**->**Ethernet Settings**.
2. Touch **IPv4 settings**.
3. Tap on "Address Type" to select DHCP, Static IP or PPPoE as the address type.
  - For DHCP, save the setting and the GXV3240 should be able to get IP address from the DHCP server in the network.
  - For static IP, enter IP Address, Subnet Mask, Default Gateway, DNS Server and Alternative DNS server for the GXV3240 to correctly connect to network.
  - For PPPoE, enter PPPoE account ID and password so the GXV3240 can get IP address from the PPPoE server.

### Wi-Fi

Wi-Fi is supported and built-in on the GXV3240. GXV3240 can be connected to network if Wi-Fi is available within the area.

#### Turn On/Off Wi-Fi

1. Go to GXV3240's **Settings**.
2. Tap on **Wireless & Network**.
3. Check or uncheck the option for **Wi-Fi**.

Or, users could open the top status bar->**System Settings** and tap on Wi-Fi icon  to turn it on/off.

#### Add Wi-Fi Networks

1. Once Wi-Fi is turned on, GXV3240 will automatically start the scanning within the range.
2. Go to GXV3240's **Settings**.
3. Tap on **Wireless & Network**.



4. Tap on **Wi-Fi Settings**.
5. A list of Wi-Fi networks will be displayed as scanning result. Tap on the SSID and enter the correct password information to connect to the selected Wi-Fi network.
6. The phone will start connecting to the Wi-Fi. The status bar will show Wi-Fi signal strength.
7. Once it's added and the password is remembered, the GXV3240 will connect to it again when the SSID is within the range.

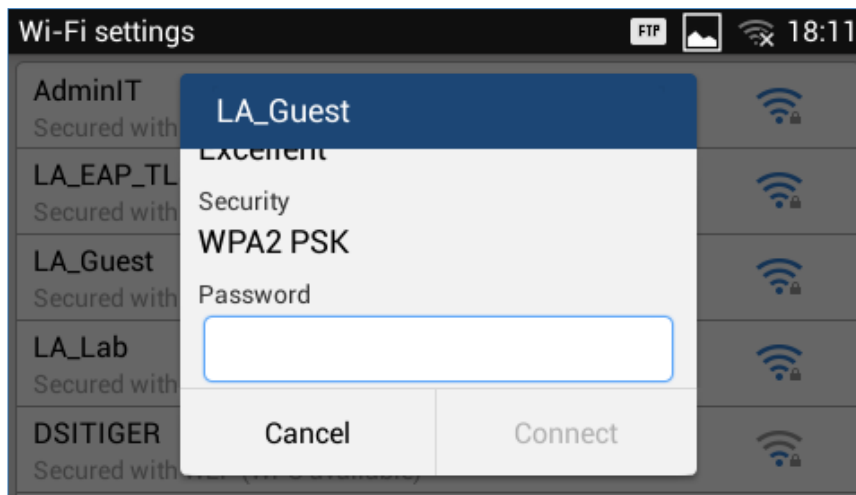


Figure 152: GXV3240 Connect to Wi-Fi

8. The previous steps allow the GXV3240 to connect the WiFi network with DHCP setting by default. If it needs to be connected to the WiFi with static IP or PPPoE setting, please scroll down the setting window and tap to check the **“Show advanced options”**. Then the window will show up the IP settings at the bottom. If Static IP is selected, the system will require end user to input IP address, Gateway, Network prefix length and DNS 1 and DNS 2 addresses. If PPPoE is selected, the system will require end user to input PPPoE account ID and password.

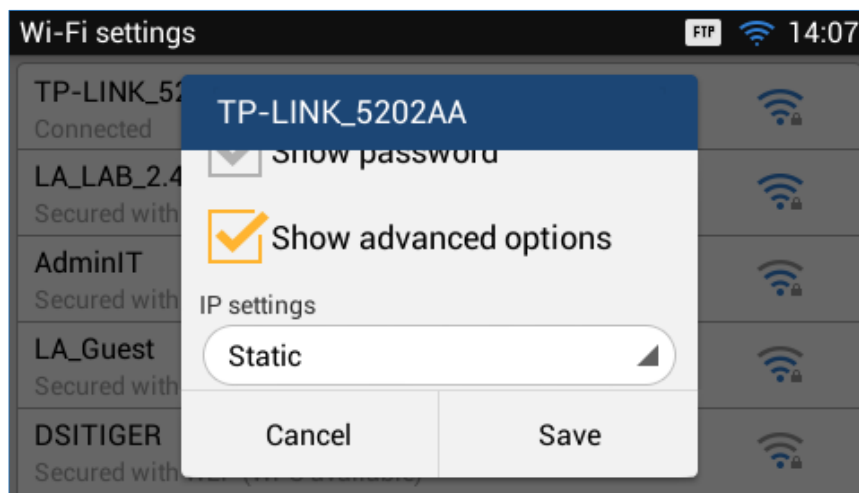


Figure 153: GXV3240 Connect to Wi-Fi-Show Advanced Options



9. If there is need to modify the saved WiFi network setting, the end user should tap and long press the SSID bar in the Wi-Fi setting page. The system will pop up a prompt and then user needs to tap the **"Modify Network"**. Then the phone system will pop up a new window to allow user to check the WiFi parameters and change the setting by checking the **"Show advanced options"** at the bottom.

For more information about how to use Wi-Fi on the GXV3240, please refer to the link below:

[http://www.grandstream.com/sites/default/files/Resources/GXV3240\\_wifi\\_guide\\_0.pdf](http://www.grandstream.com/sites/default/files/Resources/GXV3240_wifi_guide_0.pdf)

## Bluetooth

Bluetooth is a proprietary, open wireless technology standard for exchanging data over short distances from fixed and mobile devices, creating personal area networks with high levels of security. The GXV3240 supports Bluetooth Class 2, version 4.0 + EDR. Users could use Bluetooth to transfer files, share contact information with other Bluetooth portable devices, use Bluetooth headset for making calls, switch calls to the GXV3240 from mobile devices using Bluetooth hands-free profile, and listen to media (music or other audio output) from the GXV3240.

To connect to a Bluetooth device, turn on GXV3240's Bluetooth radio first. The first time when using a new Bluetooth device with the GXV3240, "pair" the device with GXV3240 so that both devices know how to connect securely to each other. After that, users could simply connect to a paired device. Turn off Bluetooth if it's not used.

Bluetooth related settings are under GXV3240's Settings-> **Wireless & Network**.


### Turn On/Off Bluetooth

1. Go to GXV3240's **Settings**.
2. Tap on **Wireless & Network**.
3. Check or uncheck the option for **Bluetooth**.

Or, users could open the top status bar->System Settings and tap on Bluetooth icon  to turn it on/off.

### Change Bluetooth Device Name


The GXV3240 uses "GXV3240" as Bluetooth device name by default. The device name will be visible to other devices when connecting them. Follow the steps below to change the name:

1. Go to GXV3240's **Settings**.
2. Turn on **Bluetooth**.
3. Select **Wireless & Network->Bluetooth settings**.
4. Press Menu button  and tap on "Rename phone".
5. Enter a name and tap on "Done".



### Pair GXV3240 with A Bluetooth Device

Before connecting GXV3240 with other Bluetooth device, users must pair them first. They will stay paired afterwards unless they are unpaired.

1. Go to GXV3240's **Settings**.
2. Select **Wireless & Network** and turn on **Bluetooth**.
3. Tap on **Bluetooth settings**.
4. Tap on the Bluetooth device to make it visible to all nearby Bluetooth devices.
5. The GXV3240 scans and displays the IDs of all available Bluetooth devices in range. If the device you would like to pair with does not show up in the list, ensure that the other device is turned on and set to be discoverable.
6. If the GXV3240 stops scanning before the other device is ready, press Menu button  and select "Search for devices".
7. Once the Bluetooth device shows up in the result, tap on it to start pairing. Confirm the passkey in the prompted message (if any). Or if passcode is required, please refer to the device's documentation or other procedures to obtain the passcode.

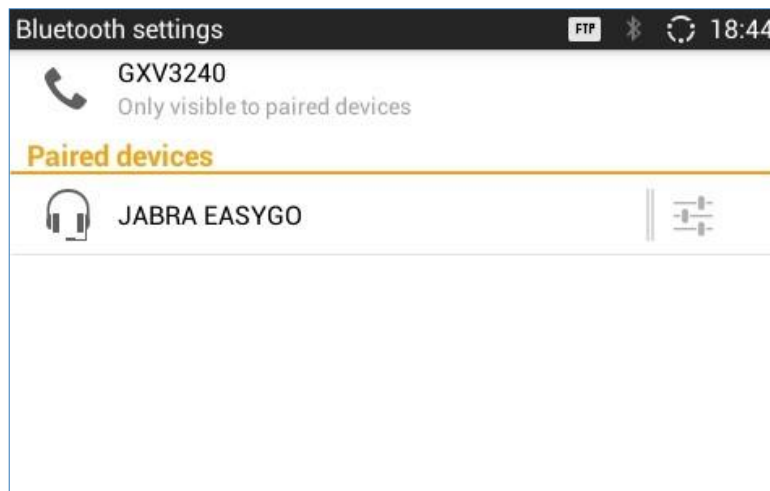


Figure 154: GXV3240 Bluetooth - Paired Device

### Unpair A Bluetooth Device

1. In the Bluetooth settings, tap on the Bluetooth device.
2. Tap on **Unpair**.



For more information about Bluetooth feature on the GXV3240, please refer to the link below:

[http://www.grandstream.com/sites/default/files/Resources/GXV3240\\_bluetooth\\_guide\\_1.pdf](http://www.grandstream.com/sites/default/files/Resources/GXV3240_bluetooth_guide_1.pdf)



## EHS Headset

The GXV3240 supports normal RJ9 headset and EHS headset (Plantronics EHS headsets only). To use EHS headset:


1. Go to the GXV3240 web GUI->**Maintenance->Device Manager**: Headset Type. Select "Plantronics EHS" and reboot the phone to take effect.
2. Connect EHS Headset to GXV3240. Insert headset connector into the RJ9 headset port on the back of GXV3240.
3. To switch to headset mode, press headset button  on the GXV3240. A headset icon  will show on the GXV3240 status bar. There are two different headset mode for users to select from web GUI-> **Maintenance->Device Manager**: Headset Key Mode. After selecting the desired mode, save the change and reboot the phone to take effect.  
Please go to <http://www.grandstream.com/support> and refer to "GXV3240 Administration Guide" for the key mode details.

## USB

The GXV3240 supports USB connection with USB storage devices. To connect and access USB storage device:

1. Insert USB storage device into USB port at the back of the GXV3240.
2. It will take a few seconds for the GXV3240 to prepare the connection. Then the USB storage icon will show on the status bar.
3. To access USB storage, go to GXV3240 MENU->**File Manager->USB Disk**. Tap on it to access and manage your data.

## SD Card

1. Insert your SD card into SD Card slot at the back of GXV3240. Please make sure the SD Card is inserted with right direction on the GXV3240 as indicated on the SD card slot.
2. It will take a few seconds for the GXV3240 to prepare the connection. Then the SD Card icon  will show on the status bar.
3. To access SD Card, go to GXV3240 MENU->**File Manager->sdcard**. Tap on it to manage your data.

## HDMI Device

1. Plug one end of the mini HDMI cable into the mini HDMI port on the GXV3240.
2. Plug the other end of the mini HDMI cable into the HDMI port on the LCD display or TV. User needs to adjust the resolution on the LCD display or TV for proper display.
3. On the GXV3240, go to **Settings->Display**. Make sure the HDMI is turned on. A HDMI icon will show



on the top status bar  .

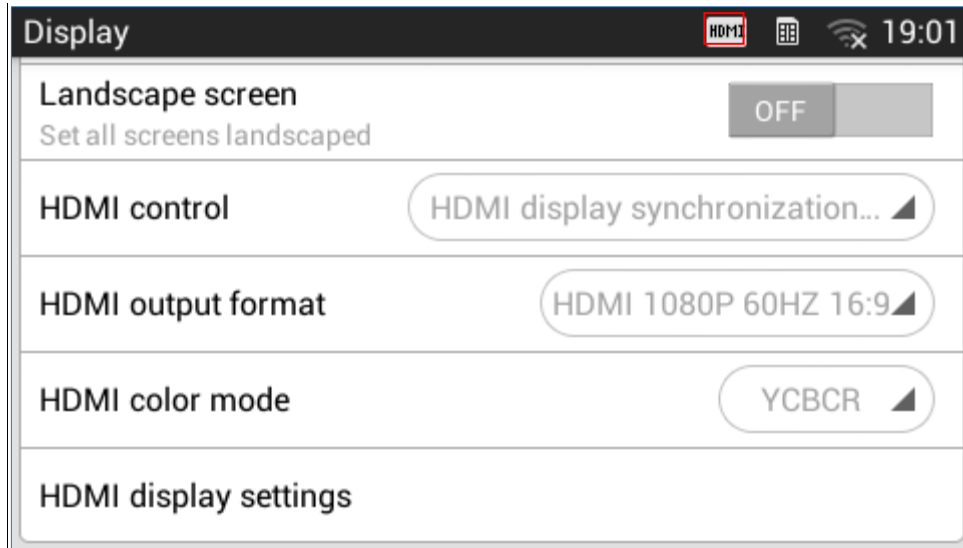


Figure 155: Settings->Display->HDMI

- In LCD **Settings->Display**, tap on “HDMI control”, a window with selections will be shown on the screen. It allows end users to set the HDMI output mode from “Close HDMI output”, “HDMI display synchronization with LCD”, “and Show remote screen”. If “Close HDMI output” is selected, the HDMI output feature will be turned off. If “HDMI display synchronization with LCD” is selected, the pictures displayed on the remote HDMI device will always be same as the GXV3240’s LCD display. If “Show remote screen” is selected, the remote HDMI device will display the same picture with the phone’s LCD screen unless displaying the remote side’s video in full size mode during a video call.

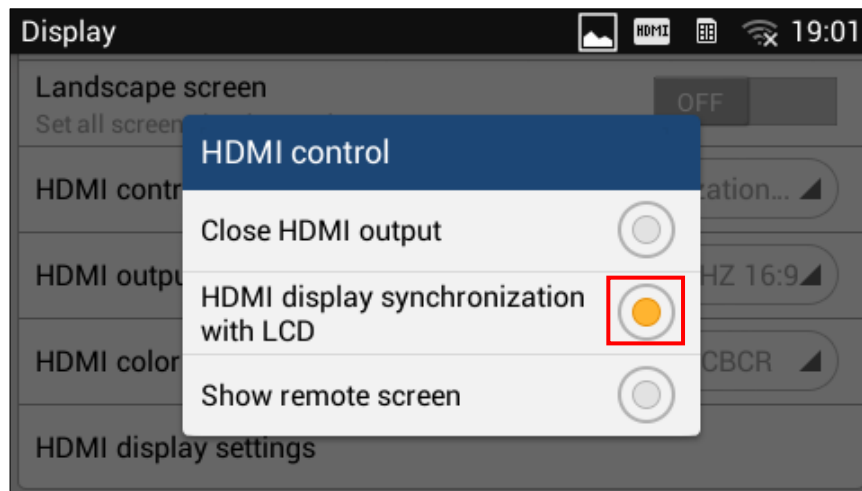


Figure 156: Settings->Display->HDMI Control



- In LCD **Settings->Display**, tap on “HDMI output format”, a window with selections will be shown on the screen. In this window, end user can set the HDMI output video quality, screen refresh rate and screen resolution for the GXV3240 device. The video quality can be selected from 480P to 720P; the screen refresh rate can be selected from 50HZ to 60HZ, and the screen resolution can be selected from 4:3 to 16:9.

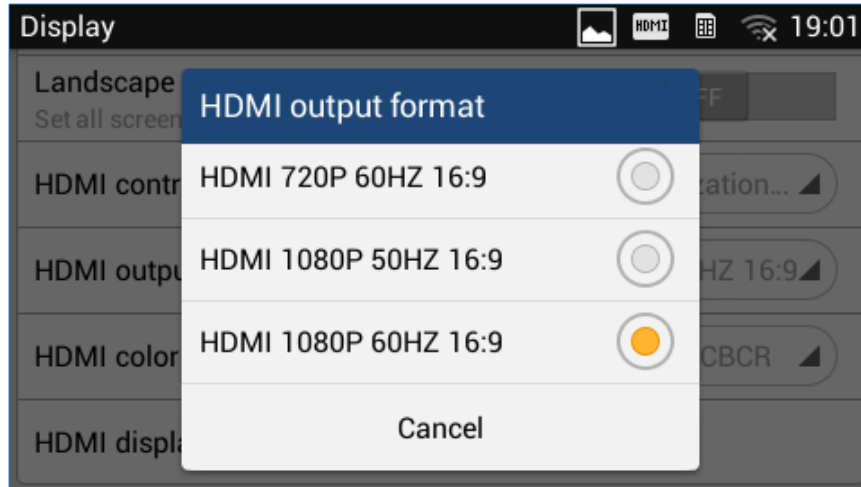


Figure 157: Settings->Display->HDMI Output Format

- In LCD **Settings->Display**, tap on “HDMI output format”, a window with selections will be shown on the screen. User can select from RGB and YCBCR, the color spaces used to represent digital component video. The RGB represents color as red, green, and blue. The YCBCR represents color as brightness and two color difference signals.

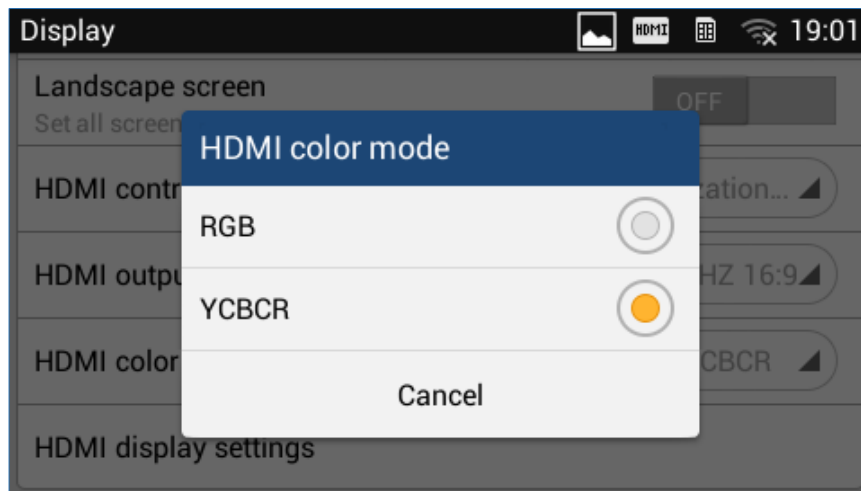


Figure 158: Settings->Display->HDMI Color Mode

- In LCD **Settings->Display**, tap on "HDMI Display Settings", an adjusting bar will be shown on the

screen. Scroll to the left or right to adjust the display on the output TV or LCD screen. Once done, tap on OK.

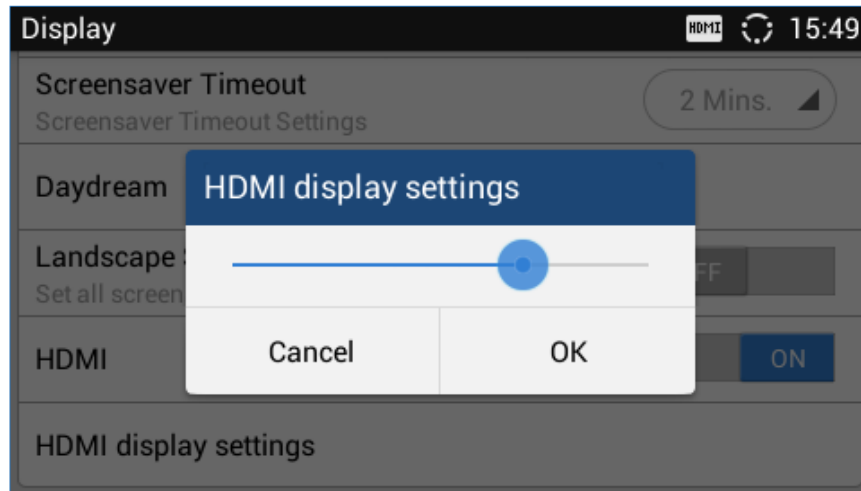


Figure 159: Settings->Display->HDMI Display Settings

8. The end user can select the audio channel while the HDMI device is connected. In LCD **Settings->Sound**, there is an audio channel setting “HDMI”. If it switched on, the audio channel will use the HDMI device. Otherwise, the audio channel will be used locally.

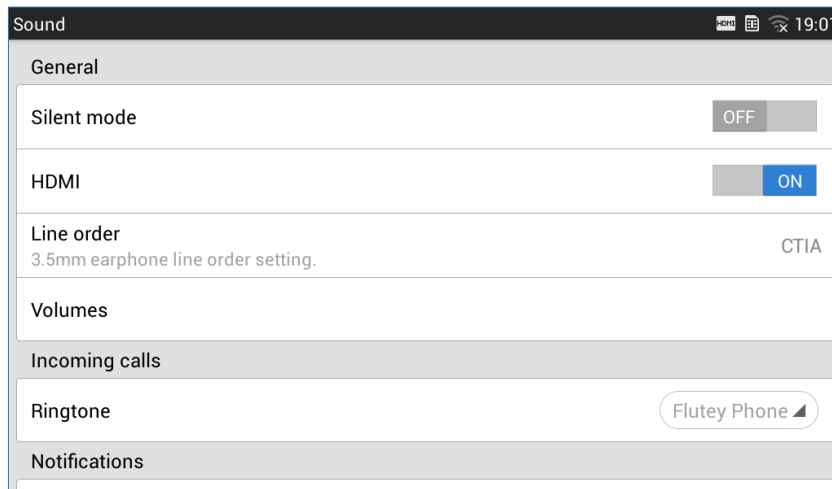


Figure 160: Settings->Display->HDMI Audio Channel Switch



## EXPERIENCING THE GXV3240 APPLICATION PHONE

Please visit our website: <http://www.grandstream.com> to receive the most up- to-date updates on firmware releases, additional features, FAQs, documentation and news on new products.

We encourage you to browse our [product related documentation](#), [FAQs](#) and [User and Developer Forum](#) for answers to your general questions. If you have purchased our products through a Grandstream Certified Partner or Reseller, please contact them directly for immediate support.

Our technical support staff is trained and ready to answer all of your questions. Contact a technical support member or [submit a trouble ticket online](#) to receive in-depth support.

Thank you again for purchasing Grandstream Enterprise Application phone, it will be sure to bring convenience and color to both your business and personal life.

---

\* Android is a trademark of Google Inc.

\* Skype and Lync are Registered Trademarks of Microsoft Corporation.

**HDMI**™

HDMI, the HDMI Logo, and High-Definition Multimedia Interface are trademarks or registered trademarks of HDMI Licensing LLC in the United States and other countries.

